



HARTNER

Precision Cutting Tools

MULTIPLEX HPC

LE SYSTÈME DE PERÇAGE À PLAQUETTES INTERCHANGEABLES
POUR DES PERÇAGES JUSQU'À 10xD
ET UN DIAMÈTRE JUSQU'À 40,0mm

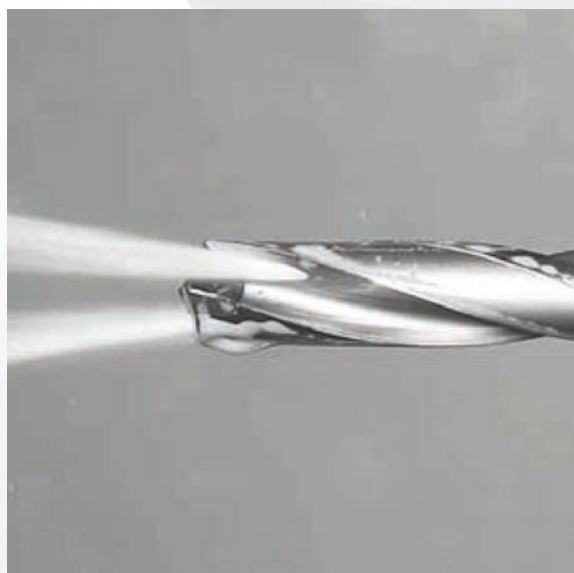





















+ nouvelle plaquette interchangeable pour l'usinage des poutrelles en acier

Code ISO

P	Aciers communs, aciers hautement alliés
M	Aciers inoxydables
K	Fontes grises, fontes à graphite sphéroïdal et fontes malléables
N	Aluminium et ses alliages ainsi que d'autres métaux non ferreux
S	Alliages de titane, spéciaux et superalliages
H	Aciers trempés et fontes dures

Pictogrammes

Matériaux de coupe	VHM
	CW monobloc
Version	      
	poli <small>AlTiN nano</small> FIRE TiAlN TiAlSiN nickelé TiN
Type	HPC
Profondeur	     
Ø-Tolérance	 
Norme	
	selon norme Hartner
Angle d'affûtage	  
Sens de coupe	 
	à droite neutre
Forme de la queue	
	selon norme DIN 6535
Aminc. de l'âme	
Lubrification intérieure	
	avec LI





MULTIPLEX HPC

▼ PORTE-OUTIL

PAGE 9



MULTIPLEX HPC

▼ PLAQUETTES INTERCHANGEABLES

PAGE 20



MULTIPLEX HPC

▼ ACCESSOIRES

PAGE 45

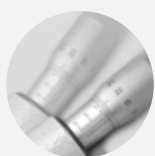

CARACTÉRISTIQUES TECHNIQUES

- ▼ LES REVÊTEMENTS
- ▼ MULTIPLEX HPC – TECHNOLOGIE ET AVANTAGES
- ▼ INCIDENTS D'USINAGE

PAGE 51



CONSEILS D'UTILISATION

PAGE 58

LE SYSTÈME D'OUTILS MODULAIRE MULTIPLEX HPC

Avec ce système de perçage à plaquettes de coupe interchangeables Multiplex HPC, Hartner fournit des supports et plaquettes interchangeables performantes et économiques pour les perçages dans une plage de diamètres de 11,00 à 40,00 mm.

Le système de perçage Multiplex HPC est donc idéal pour l'usinage de gros perçages de précision de différents matériaux de l'industrie énergétique, automobile, de construction métallique et construction de machines.

excellente tenue de coupe

- les plaquettes interchangeables sont parfaitement adaptées à chaque domaine d'application en termes de matériau de coupe, de géométrie et de surface.
- résultats d'usinage optimaux sur l'acier, l'acier inoxydable, la fonte ou l'aluminium

évacuation des copeaux optimale

- section de goujure spécifique
- surface ultra-lisse

support stable

- écarts de Ø très réduits entre chaque taille de support pour limiter l'usure
- amélioration des surfaces usinées
- un meilleur guidage de l'outil augmente la stabilité
- durée de vie de l'outil plus longue

logement de plaquette extrêmement précis

- échange des plaquettes directement sur la machine
- support restant serré
- échange de l'outil complet ou ajustage et réglage sont superflus
- assure la fiabilité du procédé d'usinage et raccourci les temps de préparation

lubrification réfrigérante parfaite

- canaux de refroidissement avec une section maximale
- sortie de goujure



MULTIPLEX HPC – PORTE-OUTIL

Le bon porte-outil adapté à chaque profondeur de perçage et à chaque application

N° d'article	86681	86682	86683	86684	86685	86686
Profondeur	1xD	1,5xD	3xD	5xD	7xD	10xD
Ø perçage	11,0-40,00	11,0-40,00	11,0-40,00	11,0-40,00	11,0-31,99	11,0-31,99
Forme de la queue	DIN 6535-HE	DIN 6535-HE	DIN 6535-HE	DIN 6535-HE	DIN 6535-HE	DIN 6535-HE
Page	19	9	11	13	15	17













Pilotage/
chanfreinage à 45°



Le support pour le perçage pilot pilote n° d'article 86681 est équipé d'une interface pour plaquettes de lamage.
Les arêtes peuvent ainsi toutes être chanfreinées à 45° lors de la réalisation d'un perçage pilote.

MULTIPLEX HPC – PLAQUETTES INTERCHANGEABLES

La bonne plaquette interchangeable adaptée à chaque matériau et à chaque application

					pour pilotage	pour poutrelles en acier
Plaquettes interchangeables						
N° d'article	86722	86725	86723	86724	86721	86729
Page	20	24	28	32	36	40
Plaquettes de lamage						
N° d'article	86728		86726	86727		
Page	42		43	44		

P	M	K	N	S	H	Norme	Type	Matière de coupe	Surface	Sens de coupe	Lubrification intérieure	Profondeur	d1/mm	N° d'article	Progr. page
---	---	---	---	---	---	-------	------	------------------	---------	---------------	--------------------------	------------	-------	--------------	-------------

Porte-outils Multiplex HPC



						Norme usine	HPC		Ⓝ	à droite	avec	1,5xD	11,000 - 39,005	86682	9
--	--	--	--	--	--	-------------	-----	--	---	----------	------	-------	-----------------	--------------	---



						Norme usine	HPC		Ⓝ	à droite	avec	3xD	11,000 - 39,005	86683	11
--	--	--	--	--	--	-------------	-----	--	---	----------	------	-----	-----------------	--------------	----



						Norme usine	HPC		Ⓝ	à droite	avec	5xD	11,000 - 39,000	86684	13
--	--	--	--	--	--	-------------	-----	--	---	----------	------	-----	-----------------	--------------	----



						Norme usine	HPC		Ⓝ	à droite	avec	7xD	11,000 - 31,505	86685	15
--	--	--	--	--	--	-------------	-----	--	---	----------	------	-----	-----------------	--------------	----



						Norme usine	HPC		Ⓝ	à droite	avec	10xD	11,000 - 31,505	86686	17
--	--	--	--	--	--	-------------	-----	--	---	----------	------	------	-----------------	--------------	----



						Norme usine			Ⓝ	à droite	avec	1xD	11,000 - 36,005	86681	19
--	--	--	--	--	--	-------------	--	--	---	----------	------	-----	-----------------	--------------	----

Plaquettes interchangeables Multiplex HPC



●	○	○				Norme usine	HPC	CW monobloc	Ⓝ	à droite			11,000 - 40,000	86722	20
---	---	---	--	--	--	-------------	-----	--------------------	---	----------	--	--	-----------------	--------------	----



○	●		○	○		Norme usine	HPC	CW monobloc	Ⓝ	à droite			11,000 - 40,000	86725	24
---	---	--	---	---	--	-------------	-----	--------------------	---	----------	--	--	-----------------	--------------	----

P	M	K	N	S	H	Norme	Type	Matière de coupe	Surface	Sens de coupe	Lubrification intérieure	Profondeur	d1/mm	N° d'article	Progr. page
---	---	---	---	---	---	-------	------	------------------	---------	---------------	--------------------------	------------	-------	--------------	-------------

Plaquettes interchangeables Multiplex HPC



○	●	○	○	○	○	Norme usine	HPC	CW monobloc	Y	à droite			11,000 - 40,000	86723	28
---	---	---	---	---	---	-------------	-----	-------------	---	----------	--	--	-----------------	-------	----



○	○	○	●	○	○	Norme usine	HPC	CW monobloc	○	à droite			11,000 - 40,000	86724	32
---	---	---	---	---	---	-------------	-----	-------------	---	----------	--	--	-----------------	-------	----



○	○	○	○	○	○	Norme usine	HPC	CW monobloc	A	à droite			11,000 - 40,000	86721	36
---	---	---	---	---	---	-------------	-----	-------------	---	----------	--	--	-----------------	-------	----



●	○	○	○	○	○	Norme usine		CW monobloc	E	à droite			12,000 - 40,000	86729	40
---	---	---	---	---	---	-------------	--	-------------	---	----------	--	--	-----------------	-------	----

Plaquette de lamage Multiplex HPC



●	○	○	○	○	○	Norme usine		CW monobloc	T	à droite			52,020 - 93,080	86728	42
---	---	---	---	---	---	-------------	--	-------------	---	----------	--	--	-----------------	-------	----



○	○	○	○	○	○	Norme usine		CW monobloc	A	neutre			52,020 - 93,080	86726	43
---	---	---	---	---	---	-------------	--	-------------	---	--------	--	--	-----------------	-------	----



○	○	○	○	○	○	Norme usine		CW monobloc	○	à droite			52,020 - 93,080	86727	44
---	---	---	---	---	---	-------------	--	-------------	---	----------	--	--	-----------------	-------	----

P	M	K	N	S	H	Norme	Type	Matière de coupe	Surface	Sens de coupe	Lubrification intérieure	Profondeur	d1/mm	N° d'article	Progr. page
---	---	---	---	---	---	-------	------	------------------	---------	---------------	--------------------------	------------	-------	--------------	-------------

Vis de serrage p. porte-outil de lamage Multiplex HPC



Norme usine

2,000 - 4,006

86846

45

Vis de serrage p. porte-outils Multiplex HPC 1,5-10xD



Norme usine

2,200 - 6,002

86843

46

Clés dynamométriques



Norme usine

1,001 - 14,000

86844

47

Embouts pour vis Torx



Norme usine

5,000 - 25,001

86845

48

Accessoires



Norme usine

5,001 - 25,001

86842

49



Porte-outils Multiplex HPC

N° d'article 86682



résistance à l'usure particulièrement élevée • section des goujures optimisée • sortie optimisée des can.de refroid. • vis de serrage n°86843 incluse • tournevis n°86842 incluse

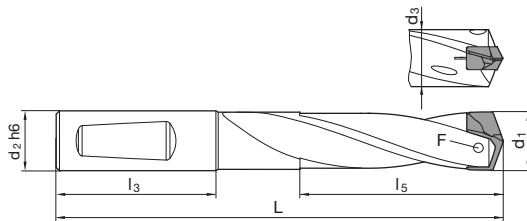

Taille mm	d1	d2 h6 mm	d3 mm	L mm	l3 mm	l5 mm	F	N° de code
110	11,00-11,49	12,000	10,700	84,000	45,000	19,300	86843 2.200	11,000
110	11,00-11,49	12,700	10,700	84,000	45,000	19,300	86843 2.200	11,005
115	11,50-11,99	12,000	11,200	85,000	45,000	20,100	86843 2.200	11,500
115	11,50-11,99	12,700	11,200	85,000	45,000	20,100	86843 2.200	11,505
120	12,00-12,49	12,000	11,700	87,000	45,000	21,000	86843 2.201	12,000
120	12,00-12,49	12,700	11,700	87,000	45,000	21,000	86843 2.201	12,005
125	12,50-12,99	14,000	12,200	89,000	45,000	21,900	86843 2.201	12,500
125	12,50-12,99	15,875	12,200	89,000	45,000	21,900	86843 2.201	12,505
130	13,00-13,49	14,000	12,700	90,000	45,000	22,600	86843 2.500	13,000
130	13,00-13,49	15,875	12,700	90,000	45,000	22,600	86843 2.500	13,005
135	13,50-13,99	14,000	13,200	92,000	45,000	23,600	86843 2.500	13,500
135	13,50-13,99	15,875	13,200	92,000	45,000	23,600	86843 2.500	13,505
140	14,00-14,49	14,000	13,700	93,000	45,000	24,500	86843 3.000	14,000
140	14,00-14,49	15,875	13,700	93,000	45,000	24,500	86843 3.000	14,005
145	14,50-14,99	16,000	14,200	98,000	48,000	25,300	86843 3.000	14,500
145	14,50-14,99	15,875	14,200	98,000	48,000	25,300	86843 3.000	14,505
150	15,00-15,49	16,000	14,700	100,000	48,000	26,100	86843 3.001	15,000
150	15,00-15,49	15,875	14,700	100,000	48,000	26,100	86843 3.001	15,005
155	15,50-15,99	16,000	15,200	101,000	48,000	27,000	86843 3.001	15,500
155	15,50-15,99	15,875	15,200	101,000	48,000	27,000	86843 3.001	15,505
160	16,00-16,49	16,000	15,700	102,000	48,000	27,800	86843 3.500	16,000
160	16,00-16,49	15,875	15,700	102,000	48,000	27,800	86843 3.500	16,005
165	16,50-16,99	18,000	16,200	105,000	48,000	28,700	86843 3.500	16,500
165	16,50-16,99	19,050	16,200	105,000	48,000	28,700	86843 3.500	16,505
170	17,00-17,49	18,000	16,700	106,000	48,000	29,600	86843 3.500	17,000
170	17,00-17,49	19,050	16,700	106,000	48,000	29,600	86843 3.500	17,005
175	17,50-17,99	18,000	17,200	107,000	48,000	30,400	86843 3.500	17,500
175	17,50-17,99	19,050	17,200	107,000	48,000	30,400	86843 3.500	17,505
180	18,00-18,49	18,000	17,700	109,000	48,000	31,200	86843 4.000	18,000
180	18,00-18,49	19,050	17,700	109,000	48,000	31,200	86843 4.000	18,005
185	18,50-18,99	20,000	18,200	113,000	50,000	32,100	86843 4.000	18,500
185	18,50-18,99	19,050	18,200	113,000	50,000	32,100	86843 4.000	18,505
190	19,00-19,49	20,000	18,700	114,000	50,000	32,900	86843 4.000	19,000
190	19,00-19,49	19,050	18,700	114,000	50,000	32,900	86843 4.000	19,005
195	19,50-19,99	20,000	19,200	116,000	50,000	33,700	86843 4.000	19,500
195	19,50-19,99	19,050	19,200	116,000	50,000	33,700	86843 4.000	19,505
200	20,00-20,49	20,000	19,700	117,000	50,000	34,600	86843 4.500	20,000
200	20,00-20,49	19,050	19,700	117,000	50,000	34,600	86843 4.500	20,005
205	20,50-20,99	25,000	20,200	128,000	56,000	35,500	86843 4.500	20,500
205	20,50-20,99	25,400	20,200	128,000	56,000	35,500	86843 4.500	20,505
210	21,00-21,49	25,000	20,700	129,000	56,000	36,400	86843 4.500	21,000
210	21,00-21,49	25,400	20,700	129,000	56,000	36,400	86843 4.500	21,005



Porte-outils Multiplex HPC

Taille mm	d1	d2 h6 mm	d3 mm	L mm	I3 mm	I5 mm	F	N° de code
215	21,50-21,99	25,000	21,200	130,000	56,000	37,200	86843 4.500	21,500
215	21,50-21,99	25,400	21,200	130,000	56,000	37,200	86843 4.500	21,505
220	22,00-22,49	25,000	21,700	131,000	56,000	38,000	86843 5.000	22,000
220	22,00-22,49	25,400	21,700	131,000	56,000	38,000	86843 5.000	22,005
225	22,50-22,99	25,000	22,200	134,000	56,000	38,900	86843 5.000	22,500
225	22,50-22,99	25,400	22,200	134,000	56,000	38,900	86843 5.000	22,505
230	23,00-23,49	25,000	22,700	135,000	56,000	39,800	86843 5.000	23,000
230	23,00-23,49	25,400	22,700	135,000	56,000	39,800	86843 5.000	23,005
235	23,50-23,99	25,000	23,200	137,000	56,000	40,600	86843 5.000	23,500
235	23,50-23,99	25,400	23,200	137,000	56,000	40,600	86843 5.000	23,505
240	24,00-24,49	25,000	23,700	138,000	56,000	41,500	86843 5.001	24,000
240	24,00-24,49	25,400	23,700	138,000	56,000	41,500	86843 5.001	24,005
245	24,50-24,99	25,000	24,200	140,000	56,000	42,300	86843 5.001	24,500
245	24,50-24,99	25,400	24,200	140,000	56,000	42,300	86843 5.001	24,505
250	25,00-25,49	25,000	24,700	142,000	56,000	43,200	86843 5.001	25,000
250	25,00-25,49	25,400	24,700	142,000	56,000	43,200	86843 5.001	25,005
255	25,50-25,99	32,000	25,200	148,000	60,000	44,000	86843 5.001	25,500
255	25,50-25,99	31,750	25,200	148,000	60,000	44,000	86843 5.001	25,505
260	26,00-26,49	32,000	25,700	151,000	60,000	44,300	86843 5.003	26,000
260	26,00-26,49	31,750	25,700	151,000	60,000	44,300	86843 5.003	26,005
265	26,50-26,99	32,000	26,200	153,000	60,000	45,100	86843 5.003	26,500
265	26,50-26,99	31,750	26,200	153,000	60,000	45,100	86843 5.003	26,505
270	27,00-27,49	32,000	26,700	155,000	60,000	46,000	86843 5.003	27,000
270	27,00-27,49	31,750	26,700	155,000	60,000	46,000	86843 5.003	27,005
275	27,50-27,99	32,000	27,200	156,000	60,000	46,800	86843 5.003	27,500
275	27,50-27,99	31,750	27,200	156,000	60,000	46,800	86843 5.003	27,505
280	28,00-28,49	32,000	27,700	157,000	60,000	47,700	86843 5.003	28,000
280	28,00-28,49	31,750	27,700	157,000	60,000	47,700	86843 5.003	28,005
285	28,50-28,99	32,000	28,200	159,000	60,000	48,500	86843 5.003	28,500
285	28,50-28,99	31,750	28,200	159,000	60,000	48,500	86843 5.003	28,505
290	29,00-29,49	32,000	28,700	161,000	60,000	49,400	86843 5.003	29,000
290	29,00-29,49	31,750	28,700	161,000	60,000	49,400	86843 5.003	29,005
295	29,50-29,99	32,000	29,200	162,000	60,000	50,200	86843 5.003	29,500
295	29,50-29,99	31,750	29,200	162,000	60,000	50,200	86843 5.003	29,505
300	30,00-30,49	32,000	29,700	164,000	60,000	50,900	86843 6.000	30,000
300	30,00-30,49	31,750	29,700	164,000	60,000	50,900	86843 6.000	30,005
305	30,50-30,99	32,000	30,200	166,000	60,000	51,700	86843 6.000	30,500
305	30,50-30,99	31,750	30,200	166,000	60,000	51,700	86843 6.000	30,505
310	31,00-31,49	32,000	30,700	167,000	60,000	52,600	86843 6.000	31,000
310	31,00-31,49	31,750	30,700	167,000	60,000	52,600	86843 6.000	31,005
315	31,50-31,99	32,000	31,200	168,000	60,000	53,400	86843 6.000	31,500
315	31,50-31,99	31,750	31,200	168,000	60,000	53,400	86843 6.000	31,505
320	32,00-32,99	32,000	31,700	172,000	60,000	55,100	86843 6.001	32,000
320	32,00-32,99	31,750	31,700	172,000	60,000	55,100	86843 6.001	32,005
330	33,00-33,99	32,000	32,700	175,000	60,000	56,800	86843 6.001	33,000
330	33,00-33,99	31,750	32,700	175,000	60,000	56,800	86843 6.001	33,005
340	34,00-34,99	32,000	33,700	178,000	60,000	58,500	86843 6.001	34,000
340	34,00-34,99	31,750	33,700	178,000	60,000	58,500	86843 6.001	34,005
350	35,00-35,99	32,000	34,700	181,000	60,000	60,200	86843 6.001	35,000
350	35,00-35,99	31,750	34,700	181,000	60,000	60,200	86843 6.001	35,005
360	36,00-36,99	32,000	35,700	184,000	60,000	61,800	86843 6.002	36,000
360	36,00-36,99	31,750	35,700	184,000	60,000	61,800	86843 6.002	36,005
370	37,00-37,99	32,000	36,700	188,000	60,000	63,500	86843 6.002	37,000
370	37,00-37,99	31,750	36,700	188,000	60,000	63,500	86843 6.002	37,005
380	38,00-38,99	32,000	37,700	191,000	60,000	65,200	86843 6.002	38,000
380	38,00-38,99	31,750	37,700	191,000	60,000	65,200	86843 6.002	38,005
390	39,00-40,00	32,000	38,700	194,000	60,000	66,900	86843 6.002	39,000
390	39,00-40,00	31,750	38,700	194,000	60,000	66,900	86843 6.002	39,005



HARTNER

Porte-outils Multiplex HPC

N° d'article 86683



résistance à l'usure particulièrement élevée • section des goujures optimisée • particulièrement rigide • vis de serrage n°86843 incluse
• tournevis n°86842 incluse

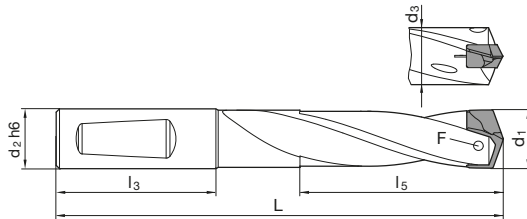

Taille mm	d1	d2 h6 mm	d3 mm	L mm	l3 mm	l5 mm	F	N° de code
110	11,00-11,49	12,000	10,700	101,000	45,000	36,600	86843 2.200	11,000
110	11,00-11,49	12,700	10,700	101,000	45,000	36,600	86843 2.200	11,005
115	11,50-11,99	12,000	11,200	103,000	45,000	38,100	86843 2.200	11,500
115	11,50-11,99	12,700	11,200	103,000	45,000	38,100	86843 2.200	11,505
120	12,00-12,49	12,000	11,700	106,000	45,000	39,700	86843 2.201	12,000
120	12,00-12,49	12,700	11,700	106,000	45,000	39,700	86843 2.201	12,005
125	12,50-12,99	14,000	12,200	108,000	45,000	41,300	86843 2.201	12,500
125	12,50-12,99	15,875	12,200	108,000	45,000	41,300	86843 2.201	12,505
130	13,00-13,49	14,000	12,700	110,000	45,000	42,900	86843 2.500	13,000
130	13,00-13,49	15,875	12,700	110,000	45,000	42,900	86843 2.500	13,005
135	13,50-13,99	14,000	13,200	113,000	45,000	44,600	86843 2.500	13,500
135	13,50-13,99	15,875	13,200	113,000	45,000	44,600	86843 2.500	13,505
140	14,00-14,49	14,000	13,700	115,000	45,000	46,200	86843 3.000	14,000
140	14,00-14,49	15,875	13,700	115,000	45,000	46,200	86843 3.000	14,005
145	14,50-14,99	16,000	14,200	120,000	48,000	47,800	86843 3.000	14,500
145	14,50-14,99	15,875	14,200	120,000	48,000	47,800	86843 3.000	14,505
150	15,00-15,49	16,000	14,700	123,000	48,000	49,300	86843 3.001	15,000
150	15,00-15,49	15,875	14,700	123,000	48,000	49,300	86843 3.001	15,005
155	15,50-15,99	16,000	15,200	125,000	48,000	50,900	86843 3.001	15,500
155	15,50-15,99	15,875	15,200	125,000	48,000	50,900	86843 3.001	15,505
160	16,00-16,49	16,000	15,700	127,000	48,000	52,900	86843 3.500	16,000
160	16,00-16,49	15,875	15,700	127,000	48,000	52,900	86843 3.500	16,005
165	16,50-16,99	18,000	16,200	130,000	48,000	54,100	86843 3.500	16,500
165	16,50-16,99	19,050	16,200	130,000	48,000	54,100	86843 3.500	16,505
170	17,00-17,49	18,000	16,700	132,000	48,000	55,800	86843 3.500	17,000
170	17,00-17,49	19,050	16,700	132,000	48,000	55,800	86843 3.500	17,005
175	17,50-17,99	18,000	17,200	134,000	48,000	57,400	86843 3.500	17,500
175	17,50-17,99	19,050	17,200	134,000	48,000	57,400	86843 3.500	17,505
180	18,00-18,49	18,000	17,700	137,000	48,000	58,900	86843 4.000	18,000
180	18,00-18,49	19,050	17,700	137,000	48,000	58,900	86843 4.000	18,005
185	18,50-18,99	20,000	18,200	141,000	50,000	60,500	86843 4.000	18,500
185	18,50-18,99	19,050	18,200	141,000	50,000	60,500	86843 4.000	18,505
190	19,00-19,49	20,000	18,700	143,000	50,000	62,100	86843 4.000	19,000
190	19,00-19,49	19,050	18,700	143,000	50,000	62,100	86843 4.000	19,005
195	19,50-19,99	20,000	19,200	146,000	50,000	63,700	86843 4.000	19,500
195	19,50-19,99	19,050	19,200	146,000	50,000	63,700	86843 4.000	19,505
200	20,00-20,49	20,000	19,700	148,000	50,000	65,300	86843 4.500	20,000
200	20,00-20,49	19,050	19,700	148,000	50,000	65,300	86843 4.500	20,005
205	20,50-20,99	25,000	20,200	159,000	56,000	67,000	86843 4.500	20,500
205	20,50-20,99	25,400	20,200	159,000	56,000	67,000	86843 4.500	20,505
210	21,00-21,49	25,000	20,700	161,000	56,000	68,600	86843 4.500	21,000
210	21,00-21,49	25,400	20,700	161,000	56,000	68,600	86843 4.500	21,005



Porte-outils Multiplex HPC

Taille mm	d1	d2 h6 mm	d3 mm	L mm	I3 mm	I5 mm	F	N° de code
215	21,50-21,99	25,000	21,200	163,000	56,000	70,100	86843 4.500	21,500
215	21,50-21,99	25,400	21,200	163,000	56,000	70,100	86843 4.500	21,505
220	22,00-22,49	25,000	21,700	165,000	56,000	71,700	86843 5.000	22,000
220	22,00-22,49	25,400	21,700	165,000	56,000	71,700	86843 5.000	22,005
225	22,50-22,99	25,000	22,200	168,000	56,000	73,300	86843 5.000	22,500
225	22,50-22,99	25,400	22,200	168,000	56,000	73,300	86843 5.000	22,505
230	23,00-23,49	25,000	22,700	170,000	56,000	74,900	86843 5.000	23,000
230	23,00-23,49	25,400	22,700	170,000	56,000	74,900	86843 5.000	23,005
235	23,50-23,99	25,000	23,200	173,000	56,000	76,500	86843 5.000	23,500
235	23,50-23,99	25,400	23,200	173,000	56,000	76,500	86843 5.000	23,505
240	24,00-24,49	25,000	23,700	175,000	56,000	78,100	86843 5.001	24,000
240	24,00-24,49	25,400	23,700	175,000	56,000	78,100	86843 5.001	24,005
245	24,50-24,99	25,000	24,200	177,000	56,000	79,700	86843 5.001	24,500
245	24,50-24,99	25,400	24,200	177,000	56,000	79,700	86843 5.001	24,505
250	25,00-25,49	25,000	24,700	180,000	56,000	81,300	86843 5.001	25,000
250	25,00-25,49	25,400	24,700	180,000	56,000	81,300	86843 5.001	25,005
255	25,50-25,99	32,000	25,200	187,000	60,000	82,900	86843 5.001	25,500
255	25,50-25,99	31,750	25,200	187,000	60,000	82,900	86843 5.001	25,505
260	26,00-26,49	32,000	25,700	191,000	60,000	84,000	86843 5.003	26,000
260	26,00-26,49	31,750	25,700	191,000	60,000	84,000	86843 5.003	26,005
265	26,50-26,99	32,000	26,200	193,000	60,000	86,100	86843 5.003	26,500
265	26,50-26,99	31,750	26,200	193,000	60,000	86,100	86843 5.003	26,505
270	27,00-27,49	32,000	26,700	196,000	60,000	87,200	86843 5.003	27,000
270	27,00-27,49	31,750	26,700	196,000	60,000	87,200	86843 5.003	27,005
275	27,50-27,99	32,000	27,200	198,000	60,000	88,900	86843 5.003	27,500
275	27,50-27,99	31,750	27,200	198,000	60,000	88,900	86843 5.003	27,505
280	28,00-28,49	32,000	27,700	200,000	60,000	90,400	86843 5.003	28,000
280	28,00-28,49	31,750	27,700	200,000	60,000	90,400	86843 5.003	28,005
285	28,50-28,99	32,000	28,200	202,000	60,000	92,500	86843 5.003	28,500
285	28,50-28,99	31,750	28,200	202,000	60,000	92,500	86843 5.003	28,505
290	29,00-29,49	32,000	28,700	205,000	60,000	94,600	86843 5.003	29,000
290	29,00-29,49	31,750	28,700	205,000	60,000	94,600	86843 5.003	29,005
295	29,50-29,99	32,000	29,200	207,000	60,000	95,100	86843 5.003	29,500
295	29,50-29,99	31,750	29,200	207,000	60,000	95,100	86843 5.003	29,505
300	30,00-30,49	32,000	29,700	210,000	60,000	96,700	86843 6.000	30,000
300	30,00-30,49	31,750	29,700	210,000	60,000	96,700	86843 6.000	30,005
305	30,50-30,99	32,000	30,200	212,000	60,000	98,300	86843 6.000	30,500
305	30,50-30,99	31,750	30,200	212,000	60,000	98,300	86843 6.000	30,505
310	31,00-31,49	32,000	30,700	214,000	60,000	99,800	86843 6.000	31,000
310	31,00-31,49	31,750	30,700	214,000	60,000	99,800	86843 6.000	31,005
315	31,50-31,99	32,000	31,200	216,000	60,000	101,400	86843 6.000	31,500
315	31,50-31,99	31,750	31,200	216,000	60,000	101,400	86843 6.000	31,505
320	32,00-32,99	32,000	31,700	221,000	60,000	104,600	86843 6.001	32,000
320	32,00-32,99	31,750	31,700	221,000	60,000	104,600	86843 6.001	32,005
330	33,00-33,99	32,000	32,700	226,000	60,000	107,800	86843 6.001	33,000
330	33,00-33,99	31,750	32,700	226,000	60,000	107,800	86843 6.001	33,005
340	34,00-34,99	32,000	33,700	230,000	60,000	111,000	86843 6.001	34,000
340	34,00-34,99	31,750	33,700	230,000	60,000	111,000	86843 6.001	34,005
350	35,00-35,99	32,000	34,700	235,000	60,000	114,200	86843 6.001	35,000
350	35,00-35,99	31,750	34,700	235,000	60,000	114,200	86843 6.001	35,005
360	36,00-36,99	32,000	35,700	240,000	60,000	117,300	86843 6.002	36,000
360	36,00-36,99	31,750	35,700	240,000	60,000	117,300	86843 6.002	36,005
370	37,00-37,99	32,000	36,700	245,000	60,000	120,500	86843 6.002	37,000
370	37,00-37,99	31,750	36,700	245,000	60,000	120,500	86843 6.002	37,005
380	38,00-38,99	32,000	37,700	249,000	60,000	123,700	86843 6.002	38,000
380	38,00-38,99	31,750	37,700	249,000	60,000	123,700	86843 6.002	38,005
390	39,00-40,00	32,000	38,700	254,000	60,000	126,900	86843 6.002	39,000
390	39,00-40,00	31,750	38,700	254,000	60,000	126,900	86843 6.002	39,005



HARTNER

Porte-outils Multiplex HPC

N° d'article 86684



résistance à l'usure particulièrement élevée • section des goujures optimisée • particulièrement rigide • vis de serrage n°86843 incluse
• tournevis n°86842 incluse

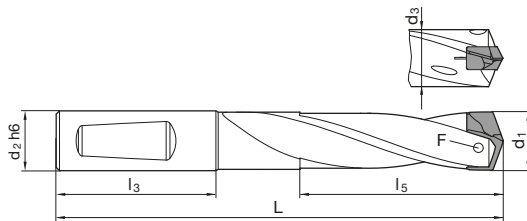

Taille mm	d1	d2 h6 mm	d3 mm	L mm	l3 mm	l5 mm	F	N° de code
110	11,00-11,49	12,000	10,700	124,000	45,000	59,600	86843 2.200	11,000
110	11,00-11,49	12,700	10,700	124,000	45,000	59,600	86843 2.200	11,005
115	11,50-11,99	12,000	11,200	127,000	45,000	62,100	86843 2.200	11,500
115	11,50-11,99	12,700	11,200	127,000	45,000	62,100	86843 2.200	11,505
120	12,00-12,49	12,000	11,700	131,000	45,000	64,700	86843 2.201	12,000
120	12,00-12,49	12,700	11,700	131,000	45,000	64,700	86843 2.201	12,005
125	12,50-12,99	14,000	12,200	134,000	45,000	67,300	86843 2.201	12,500
125	12,50-12,99	15,875	12,200	134,000	45,000	67,300	86843 2.201	12,505
130	13,00-13,49	14,000	12,700	137,000	45,000	69,900	86843 2.500	13,000
130	13,00-13,49	15,875	12,700	137,000	45,000	69,900	86843 2.500	13,005
135	13,50-13,99	14,000	13,200	141,000	45,000	72,600	86843 2.500	13,500
135	13,50-13,99	15,875	13,200	141,000	45,000	72,600	86843 2.500	13,505
140	14,00-14,49	14,000	13,700	144,000	45,000	75,200	86843 3.000	14,000
140	14,00-14,49	15,875	13,700	144,000	45,000	75,200	86843 3.000	14,005
145	14,50-14,99	16,000	14,200	150,000	48,000	77,800	86843 3.000	14,500
145	14,50-14,99	15,875	14,200	150,000	48,000	77,800	86843 3.000	14,505
150	15,00-15,49	16,000	14,700	154,000	48,000	80,300	86843 3.001	15,000
150	15,00-15,49	15,875	14,700	154,000	48,000	80,300	86843 3.001	15,005
155	15,50-15,99	16,000	15,200	157,000	48,000	82,900	86843 3.001	15,500
155	15,50-15,99	15,875	15,200	157,000	48,000	82,900	86843 3.001	15,505
160	16,00-16,49	16,000	15,700	160,000	48,000	85,900	86843 3.500	16,000
160	16,00-16,49	15,875	15,700	160,000	48,000	85,900	86843 3.500	16,005
165	16,50-16,99	18,000	16,200	164,000	48,000	88,100	86843 3.500	16,500
165	16,50-16,99	19,050	16,200	164,000	48,000	88,100	86843 3.500	16,505
170	17,00-17,49	18,000	16,700	167,000	48,000	90,800	86843 3.500	17,000
170	17,00-17,49	19,050	16,700	167,000	48,000	90,800	86843 3.500	17,005
175	17,50-17,99	18,000	17,200	170,000	48,000	93,400	86843 3.500	17,500
175	17,50-17,99	19,050	17,200	170,000	48,000	93,400	86843 3.500	17,505
180	18,00-18,49	18,000	17,700	174,000	48,000	95,900	86843 4.000	18,000
180	18,00-18,49	19,050	17,700	174,000	48,000	95,900	86843 4.000	18,005
185	18,50-18,99	20,000	18,200	179,000	50,000	98,500	86843 4.000	18,500
185	18,50-18,99	19,050	18,200	179,000	50,000	98,500	86843 4.000	18,505
190	19,00-19,49	20,000	18,700	182,000	50,000	101,100	86843 4.000	19,000
190	19,00-19,49	19,050	18,700	182,000	50,000	101,100	86843 4.000	19,005
195	19,50-19,99	20,000	19,200	186,000	50,000	103,700	86843 4.000	19,500
195	19,50-19,99	19,050	19,200	186,000	50,000	103,700	86843 4.000	19,505
200	20,00-20,49	20,000	19,700	189,000	50,000	106,300	86843 4.500	20,000
200	20,00-20,49	19,050	19,700	189,000	50,000	106,300	86843 4.500	20,005
205	20,50-20,99	25,000	20,200	201,000	56,000	109,000	86843 4.500	20,500
205	20,50-20,99	25,400	20,200	201,000	56,000	109,000	86843 4.500	20,505
210	21,00-21,49	25,000	20,700	204,000	56,000	111,600	86843 4.500	21,000
210	21,00-21,49	25,400	20,700	204,000	56,000	111,600	86843 4.500	21,005



Porte-outils Multiplex HPC

Taille mm	d1	d2 h6 mm	d3 mm	L mm	I3 mm	I5 mm	F	N° de code
215	21,50-21,99	25,000	21,200	207,000	56,000	114,100	86843 4.500	21,500
215	21,50-21,99	25,400	21,200	207,000	56,000	114,100	86843 4.500	21,505
220	22,00-22,49	25,000	21,700	210,000	56,000	116,700	86843 5.000	22,000
220	22,00-22,49	25,400	21,700	210,000	56,000	116,700	86843 5.000	22,005
225	22,50-22,99	25,000	22,200	214,000	56,000	119,300	86843 5.000	22,500
225	22,50-22,99	25,400	22,200	214,000	56,000	119,300	86843 5.000	22,505
230	23,00-23,49	25,000	22,700	217,000	56,000	121,900	86843 5.000	23,000
230	23,00-23,49	25,400	22,700	217,000	56,000	121,900	86843 5.000	23,005
235	23,50-23,99	25,000	23,200	221,000	56,000	124,500	86843 5.000	23,500
235	23,50-23,99	25,400	23,200	221,000	56,000	124,500	86843 5.000	23,505
240	24,00-24,49	25,000	23,700	224,000	56,000	127,100	86843 5.001	24,000
240	24,00-24,49	25,400	23,700	224,000	56,000	127,100	86843 5.001	24,005
245	24,50-24,99	25,000	24,200	227,000	56,000	129,700	86843 5.001	24,500
245	24,50-24,99	25,400	24,200	227,000	56,000	129,700	86843 5.001	24,505
250	25,00-25,49	25,000	24,700	231,000	56,000	132,300	86843 5.001	25,000
250	25,00-25,49	25,400	24,700	231,000	56,000	132,300	86843 5.001	25,005
255	25,50-25,99	32,000	25,200	239,000	60,000	134,900	86843 5.001	25,500
255	25,50-25,99	31,750	25,200	239,000	60,000	134,900	86843 5.001	25,505
260	26,00-26,49	32,000	25,700	244,000	60,000	137,000	86843 5.003	26,000
265	26,50-26,99	32,000	26,200	247,000	60,000	140,000	86843 5.003	26,500
270	27,00-27,49	32,000	26,700	251,000	60,000	142,200	86843 5.003	27,000
275	27,50-27,99	32,000	27,200	254,000	60,000	144,800	86843 5.003	27,500
280	28,00-28,49	32,000	27,700	257,000	60,000	147,400	86843 5.003	28,000
285	28,50-28,99	32,000	28,200	260,000	60,000	150,400	86843 5.003	28,500
290	29,00-29,49	32,000	28,700	264,000	60,000	153,500	86843 5.003	29,000
295	29,50-29,99	32,000	29,200	267,000	60,000	155,100	86843 5.003	29,500
300	30,00-30,49	32,000	29,700	271,000	60,000	157,600	86843 6.000	30,000
305	30,50-30,99	32,000	30,200	274,000	60,000	160,200	86843 6.000	30,500
310	31,00-31,49	32,000	30,700	277,000	60,000	162,800	86843 6.000	31,000
315	31,50-31,99	32,000	31,200	280,000	60,000	165,400	86843 6.000	31,500
320	32,00-32,99	32,000	31,700	287,000	60,000	170,600	86843 6.001	32,000
330	33,00-33,99	32,000	32,700	294,000	60,000	175,800	86843 6.001	33,000
340	34,00-34,99	32,000	33,700	300,000	60,000	181,000	86843 6.001	34,000
350	35,00-35,99	32,000	34,700	307,000	60,000	186,200	86843 6.001	35,000
360	36,00-36,99	32,000	35,700	314,000	60,000	191,300	86843 6.002	36,000
370	37,00-37,99	32,000	36,700	321,000	60,000	196,500	86843 6.002	37,000
380	38,00-38,99	32,000	37,700	327,000	60,000	201,700	86843 6.002	38,000
390	39,00-40,00	32,000	38,700	334,000	60,000	206,900	86843 6.002	39,000



HARTNER

Porte-outils Multiplex HPC

N° d'article 86685



résistance à l'usure particulièrement élevée • section des goujures optimisée • particulièrement rigide • vis de serrage n°86843 incluse
• tournevis n°86842 incluse

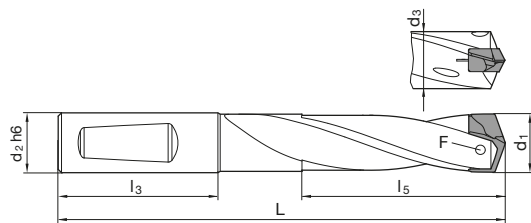

Taille mm	d1	d2 h6 mm	d3 mm	L mm	l3 mm	l5 mm	F	N° de code
110	11,00-11,49	12,000	10,700	147,000	45,000	82,600	86843 2.200	11,000
110	11,00-11,49	12,700	10,700	147,000	45,000	82,600	86843 2.200	11,005
115	11,50-11,99	12,000	11,200	151,000	45,000	86,100	86843 2.200	11,500
115	11,50-11,99	12,700	11,200	151,000	45,000	86,100	86843 2.200	11,505
120	12,00-12,49	12,000	11,700	156,000	45,000	89,700	86843 2.201	12,000
120	12,00-12,49	12,700	11,700	156,000	45,000	89,700	86843 2.201	12,005
125	12,50-12,99	14,000	12,200	160,000	45,000	93,300	86843 2.201	12,500
125	12,50-12,99	15,875	12,200	160,000	45,000	93,300	86843 2.201	12,505
130	13,00-13,49	14,000	12,700	164,000	45,000	96,900	86843 2.500	13,000
130	13,00-13,49	15,875	12,700	164,000	45,000	96,900	86843 2.500	13,005
135	13,50-13,99	14,000	13,200	169,000	45,000	100,600	86843 2.500	13,500
135	13,50-13,99	15,875	13,200	169,000	45,000	100,600	86843 2.500	13,505
140	14,00-14,49	14,000	13,700	173,000	45,000	104,200	86843 3.000	14,000
140	14,00-14,49	15,875	13,700	173,000	45,000	104,200	86843 3.000	14,005
145	14,50-14,99	16,000	14,200	180,000	48,000	107,800	86843 3.000	14,500
145	14,50-14,99	15,875	14,200	180,000	48,000	107,800	86843 3.000	14,505
150	15,00-15,49	16,000	14,700	185,000	48,000	111,300	86843 3.001	15,000
150	15,00-15,49	15,875	14,700	185,000	48,000	111,300	86843 3.001	15,005
155	15,50-15,99	16,000	15,200	189,000	48,000	114,900	86843 3.001	15,500
155	15,50-15,99	15,875	15,200	189,000	48,000	114,900	86843 3.001	15,505
160	16,00-16,49	16,000	15,700	193,000	48,000	118,900	86843 3.500	16,000
160	16,00-16,49	15,875	15,700	193,000	48,000	118,900	86843 3.500	16,005
165	16,50-16,99	18,000	16,200	198,000	48,000	122,100	86843 3.500	16,500
165	16,50-16,99	19,050	16,200	198,000	48,000	122,100	86843 3.500	16,505
170	17,00-17,49	18,000	16,700	202,000	48,000	125,800	86843 3.500	17,000
170	17,00-17,49	19,050	16,700	202,000	48,000	125,800	86843 3.500	17,005
175	17,50-17,99	18,000	17,200	206,000	48,000	129,400	86843 3.500	17,500
175	17,50-17,99	19,050	17,200	206,000	48,000	129,400	86843 3.500	17,505
180	18,00-18,49	18,000	17,700	211,000	48,000	132,900	86843 4.000	18,000
180	18,00-18,49	19,050	17,700	211,000	48,000	132,900	86843 4.000	18,005
185	18,50-18,99	20,000	18,200	217,000	50,000	136,500	86843 4.000	18,500
185	18,50-18,99	19,050	18,200	217,000	50,000	136,500	86843 4.000	18,505
190	19,00-19,49	20,000	18,700	221,000	50,000	140,100	86843 4.000	19,000
190	19,00-19,49	19,050	18,700	221,000	50,000	140,100	86843 4.000	19,005
195	19,50-19,99	20,000	19,200	226,000	50,000	143,700	86843 4.000	19,500
195	19,50-19,99	19,050	19,200	226,000	50,000	143,700	86843 4.000	19,505
200	20,00-20,49	20,000	19,700	230,000	50,000	147,300	86843 4.500	20,000
200	20,00-20,49	19,050	19,700	230,000	50,000	147,300	86843 4.500	20,005
205	20,50-20,99	25,000	20,200	243,000	56,000	151,000	86843 4.500	20,500
205	20,50-20,99	25,400	20,200	243,000	56,000	151,000	86843 4.500	20,505
210	21,00-21,49	25,000	20,700	247,000	56,000	154,600	86843 4.500	21,000
210	21,00-21,49	25,400	20,700	247,000	56,000	154,600	86843 4.500	21,005



Porte-outils Multiplex HPC

Taille mm	d1	d2 h6 mm	d3 mm	L mm	I3 mm	I5 mm	F	N° de code
215	21,50-21,99	25,000	21,200	251,000	56,000	158,100	86843 4.500	21,500
215	21,50-21,99	25,400	21,200	251,000	56,000	158,100	86843 4.500	21,505
220	22,00-22,49	25,000	21,700	255,000	56,000	161,700	86843 5.000	22,000
220	22,00-22,49	25,400	21,700	255,000	56,000	161,700	86843 5.000	22,005
225	22,50-22,99	25,000	22,200	260,000	56,000	165,300	86843 5.000	22,500
225	22,50-22,99	25,400	22,200	260,000	56,000	165,300	86843 5.000	22,505
230	23,00-23,49	25,000	22,700	264,000	56,000	168,900	86843 5.000	23,000
230	23,00-23,49	25,400	22,700	264,000	56,000	168,900	86843 5.000	23,005
235	23,50-23,99	25,000	23,200	269,000	56,000	172,500	86843 5.000	23,500
235	23,50-23,99	25,400	23,200	269,000	56,000	172,500	86843 5.000	23,505
240	24,00-24,49	25,000	23,700	273,000	56,000	176,100	86843 5.001	24,000
240	24,00-24,49	25,400	23,700	273,000	56,000	176,100	86843 5.001	24,005
245	24,50-24,99	25,000	24,200	277,000	56,000	179,700	86843 5.001	24,500
245	24,50-24,99	25,400	24,200	277,000	56,000	179,700	86843 5.001	24,505
250	25,00-25,49	25,000	24,700	282,000	56,000	183,300	86843 5.001	25,000
250	25,00-25,49	25,400	24,700	282,000	56,000	183,300	86843 5.001	25,005
255	25,50-25,99	32,000	25,200	291,000	60,000	186,900	86843 5.001	25,500
255	25,50-25,99	31,750	25,200	291,000	60,000	186,900	86843 5.001	25,505
260	26,00-26,49	32,000	25,700	297,000	60,000	190,000	86843 5.003	26,000
260	26,00-26,49	31,750	25,700	297,000	60,000	190,000	86843 5.003	26,005
265	26,50-26,99	32,000	26,200	301,000	60,000	194,000	86843 5.003	26,500
265	26,50-26,99	31,750	26,200	301,000	60,000	194,000	86843 5.003	26,505
270	27,00-27,49	32,000	26,700	306,000	60,000	197,200	86843 5.003	27,000
270	27,00-27,49	31,750	26,700	306,000	60,000	197,200	86843 5.003	27,005
275	27,50-27,99	32,000	27,200	310,000	60,000	200,800	86843 5.003	27,500
275	27,50-27,99	31,750	27,200	310,000	60,000	200,800	86843 5.003	27,505
280	28,00-28,49	32,000	27,700	314,000	60,000	204,400	86843 5.003	28,000
280	28,00-28,49	31,750	27,700	314,000	60,000	204,400	86843 5.003	28,005
285	28,50-28,99	32,000	28,200	318,000	60,000	208,400	86843 5.003	28,500
285	28,50-28,99	31,750	28,200	318,000	60,000	208,400	86843 5.003	28,505
290	29,00-29,49	32,000	28,700	323,000	60,000	212,500	86843 5.003	29,000
290	29,00-29,49	31,750	28,700	323,000	60,000	212,500	86843 5.003	29,005
295	29,50-29,99	32,000	29,200	327,000	60,000	215,100	86843 5.003	29,500
295	29,50-29,99	31,750	29,200	327,000	60,000	215,100	86843 5.003	29,505
300	30,00-30,49	32,000	29,700	332,000	60,000	218,600	86843 6.000	30,000
300	30,00-30,49	31,750	29,700	332,000	60,000	218,600	86843 6.000	30,005
305	30,50-30,99	32,000	30,200	336,000	60,000	222,200	86843 6.000	30,500
305	30,50-30,99	31,750	30,200	336,000	60,000	222,200	86843 6.000	30,505
310	31,00-31,49	32,000	30,700	340,000	60,000	225,800	86843 6.000	31,000
310	31,00-31,49	31,750	30,700	340,000	60,000	225,800	86843 6.000	31,005
315	31,50-31,99	32,000	31,200	344,000	60,000	229,400	86843 6.000	31,500
315	31,50-31,99	31,750	31,200	344,000	60,000	229,400	86843 6.000	31,505



HARTNER

Porte-outils Multiplex HPC

N° d'article 86686



résistance à l'usure particulièrement élevée • section des goujures optimisée • particulièrement rigide • vis de serrage n°86843 incluse
• tournevis n°86842 incluse

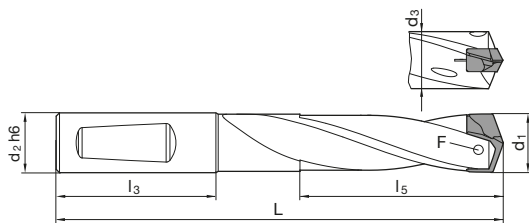

Taille mm	d1	d2 h6 mm	d3 mm	L mm	l3 mm	l5 mm	F	N° de code
110	11,00-11,49	12,000	10,700	182,000	45,000	117,100	86843 2.200	11,000
110	11,00-11,49	12,700	10,700	182,000	45,000	117,100	86843 2.200	11,005
115	11,50-11,99	12,000	11,200	187,000	45,000	122,100	86843 2.200	11,500
115	11,50-11,99	12,700	11,200	187,000	45,000	122,100	86843 2.200	11,505
120	12,00-12,49	12,000	11,700	194,000	45,000	127,200	86843 2.201	12,000
120	12,00-12,49	12,700	11,700	194,000	45,000	127,200	86843 2.201	12,005
125	12,50-12,99	14,000	12,200	199,000	45,000	132,300	86843 2.201	12,500
125	12,50-12,99	15,875	12,200	199,000	45,000	132,300	86843 2.201	12,505
130	13,00-13,49	14,000	12,700	205,000	45,000	137,500	86843 2.500	13,000
130	13,00-13,49	15,875	12,700	205,000	45,000	137,500	86843 2.500	13,005
135	13,50-13,99	14,000	13,200	211,000	45,000	142,500	86843 2.500	13,500
135	13,50-13,99	15,875	13,200	211,000	45,000	142,500	86843 2.500	13,505
140	14,00-14,49	14,000	13,700	217,000	45,000	147,700	86843 3.000	14,000
140	14,00-14,49	15,875	13,700	217,000	45,000	147,700	86843 3.000	14,005
145	14,50-14,99	16,000	14,200	225,000	48,000	152,800	86843 3.000	14,500
145	14,50-14,99	15,875	14,200	225,000	48,000	152,800	86843 3.000	14,505
150	15,00-15,49	16,000	14,700	232,000	48,000	157,800	86843 3.001	15,000
150	15,00-15,49	15,875	14,700	232,000	48,000	157,800	86843 3.001	15,005
155	15,50-15,99	16,000	15,200	237,000	48,000	162,900	86843 3.001	15,500
155	15,50-15,99	15,875	15,200	237,000	48,000	162,900	86843 3.001	15,505
160	16,00-16,49	16,000	15,700	243,000	48,000	168,000	86843 3.500	16,000
160	16,00-16,49	15,875	15,700	243,000	48,000	168,000	86843 3.500	16,005
165	16,50-16,99	18,000	16,200	249,000	48,000	170,000	86843 3.500	16,500
165	16,50-16,99	19,050	16,200	249,000	48,000	170,000	86843 3.500	16,505
170	17,00-17,49	18,000	16,700	255,000	48,000	178,300	86843 3.500	17,000
170	17,00-17,49	19,050	16,700	255,000	48,000	178,300	86843 3.500	17,005
175	17,50-17,99	18,000	17,200	260,000	48,000	183,500	86843 3.500	17,500
175	17,50-17,99	19,050	17,200	260,000	48,000	183,500	86843 3.500	17,505
180	18,00-18,49	18,000	17,700	267,000	48,000	188,400	86843 4.000	18,000
180	18,00-18,49	19,050	17,700	267,000	48,000	188,400	86843 4.000	18,005
185	18,50-18,99	20,000	18,200	274,000	50,000	193,500	86843 4.000	18,500
185	18,50-18,99	19,050	18,200	274,000	50,000	193,500	86843 4.000	18,505
190	19,00-19,49	20,000	18,700	280,000	50,000	198,700	86843 4.000	19,000
190	19,00-19,49	19,050	18,700	280,000	50,000	198,700	86843 4.000	19,005
195	19,50-19,99	20,000	19,200	286,000	50,000	203,700	86843 4.000	19,500
195	19,50-19,99	19,050	19,200	286,000	50,000	203,700	86843 4.000	19,505
200	20,00-20,49	20,000	19,700	292,000	50,000	208,900	86843 4.500	20,000
200	20,00-20,49	19,050	19,700	292,000	50,000	208,900	86843 4.500	20,005
205	20,50-20,99	25,000	20,200	306,000	56,000	214,000	86843 4.500	20,500
205	20,50-20,99	25,400	20,200	306,000	56,000	214,000	86843 4.500	20,505
210	21,00-21,49	25,000	20,700	312,000	56,000	219,100	86843 4.500	21,000
210	21,00-21,49	25,400	20,700	312,000	56,000	219,100	86843 4.500	21,005



Porte-outils Multiplex HPC

Taille mm	d1	d2 h6 mm	d3 mm	L mm	I3 mm	I5 mm	F	N° de code
215	21,50-21,99	25,000	21,200	317,000	56,000	224,200	86843 4.500	21,500
215	21,50-21,99	25,400	21,200	317,000	56,000	224,200	86843 4.500	21,505
220	22,00-22,49	25,000	21,700	323,000	56,000	229,300	86843 5.000	22,000
220	22,00-22,49	25,400	21,700	323,000	56,000	229,300	86843 5.000	22,005
225	22,50-22,99	25,000	22,200	329,000	56,000	234,400	86843 5.000	22,500
225	22,50-22,99	25,400	22,200	329,000	56,000	234,400	86843 5.000	22,505
230	23,00-23,49	25,000	22,700	335,000	56,000	239,500	86843 5.000	23,000
230	23,00-23,49	25,400	22,700	335,000	56,000	239,500	86843 5.000	23,005
235	23,50-23,99	25,000	23,200	341,000	56,000	244,600	86843 5.000	23,500
235	23,50-23,99	25,400	23,200	341,000	56,000	244,600	86843 5.000	23,505
240	24,00-24,49	25,000	23,700	347,000	56,000	249,700	86843 5.001	24,000
240	24,00-24,49	25,400	23,700	347,000	56,000	249,700	86843 5.001	24,005
245	24,50-24,99	25,000	24,200	352,000	56,000	254,800	86843 5.001	24,500
245	24,50-24,99	25,400	24,200	352,000	56,000	254,800	86843 5.001	24,505
250	25,00-25,49	25,000	24,700	359,000	56,000	259,900	86843 5.001	25,000
250	25,00-25,49	25,400	24,700	359,000	56,000	259,900	86843 5.001	25,005
255	25,50-25,99	32,000	25,200	369,000	60,000	265,000	86843 5.001	25,500
255	25,50-25,99	31,750	25,200	369,000	60,000	265,000	86843 5.001	25,505
260	26,00-26,49	32,000	25,700	377,000	60,000	270,000	86843 5.003	26,000
260	26,00-26,49	31,750	25,700	377,000	60,000	270,000	86843 5.003	26,005
265	26,50-26,99	32,000	26,200	382,000	60,000	275,000	86843 5.003	26,500
265	26,50-26,99	31,750	26,200	382,000	60,000	275,000	86843 5.003	26,505
270	27,00-27,49	32,000	26,700	388,000	60,000	280,100	86843 5.003	27,000
270	27,00-27,49	31,750	26,700	388,000	60,000	280,100	86843 5.003	27,005
275	27,50-27,99	32,000	27,200	394,000	60,000	285,200	86843 5.003	27,500
275	27,50-27,99	31,750	27,200	394,000	60,000	285,200	86843 5.003	27,505
280	28,00-28,49	32,000	27,700	400,000	60,000	290,300	86843 5.003	28,000
280	28,00-28,49	31,750	27,700	400,000	60,000	290,300	86843 5.003	28,005
285	28,50-28,99	32,000	28,200	405,000	60,000	295,400	86843 5.003	28,500
285	28,50-28,99	31,750	28,200	405,000	60,000	295,400	86843 5.003	28,505
290	29,00-29,49	32,000	28,700	412,000	60,000	300,500	86843 5.003	29,000
290	29,00-29,49	31,750	28,700	412,000	60,000	300,500	86843 5.003	29,005
295	29,50-29,99	32,000	29,200	418,000	60,000	305,600	86843 5.003	29,500
295	29,50-29,99	31,750	29,200	418,000	60,000	305,600	86843 5.003	29,505
300	30,00-30,49	32,000	29,700	424,000	60,000	310,600	86843 6.000	30,000
300	30,00-30,49	31,750	29,700	424,000	60,000	310,600	86843 6.000	30,005
305	30,50-30,99	32,000	30,200	429,000	60,000	315,700	86843 6.000	30,500
305	30,50-30,99	31,750	30,200	429,000	60,000	315,700	86843 6.000	30,505
310	31,00-31,49	32,000	30,700	435,000	60,000	320,800	86843 6.000	31,000
310	31,00-31,49	31,750	30,700	435,000	60,000	320,800	86843 6.000	31,005
315	31,50-31,99	32,000	31,200	441,000	60,000	325,900	86843 6.000	31,500
315	31,50-31,99	31,750	31,200	441,000	60,000	325,900	86843 6.000	31,505



Porte-outils Multiplex HPC

N° d'article 86681



résistance à l'usure particulièrement élevée • section des goujures optimisée • sortie optimisée des can.de refroid. • y compris vis de serrage n° d'article 86843 et 86846 • tournevis n°86842 incluse

p. pilotes de guid.et chanfr. 45°

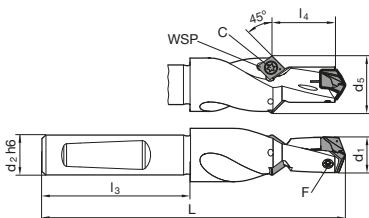

Taille mm	d1	d2 h6 mm	d5 mm	L mm	l3 mm	l4 mm	F	C	N° de code
110	11,00-11,99	12,000	17,000	81,000	45,000	12,000	86843 2.200	86846 2.000	11,000
110	11,00-11,99	12,700	17,000	81,000	45,000	12,000	86843 2.200	86846 2.000	11,005
120	12,00-12,99	12,000	18,000	84,000	45,000	13,000	86843 2.201	86846 2.000	12,000
120	12,00-12,99	12,700	18,000	84,000	45,000	13,000	86843 2.201	86846 2.000	12,005
130	13,00-13,99	14,000	18,000	86,000	45,000	14,000	86843 2.500	86846 2.000	13,000
130	13,00-13,99	15,875	18,000	86,000	45,000	14,000	86843 2.500	86846 2.000	13,005
140	14,00-15,99	16,000	18,000	93,000	48,000	16,000	86843 3.000	86846 2.000	14,000
140	14,00-15,99	15,875	18,000	93,000	48,000	16,000	86843 3.000	86846 2.000	14,005
160	16,00-17,99	18,000	20,000	99,000	48,000	18,000	86843 3.500	86846 2.500	16,000
160	16,00-17,99	19,050	20,000	99,000	48,000	18,000	86843 3.500	86846 2.500	16,005
180	18,00-19,99	20,000	22,000	106,000	50,000	20,000	86843 4.000	86846 2.500	18,000
180	18,00-19,99	19,050	22,000	106,000	50,000	20,000	86843 4.000	86846 2.500	18,005
200	20,00-21,99	25,000	25,000	117,000	56,000	22,000	86843 4.500	86846 2.500	20,000
200	20,00-21,99	25,400	25,400	117,000	56,000	22,000	86843 4.500	86846 2.500	20,005
220	22,00-23,99	25,000	26,000	122,000	56,000	24,000	86843 5.000	86846 2.500	22,000
220	22,00-23,99	25,400	26,000	122,000	56,000	24,000	86843 5.000	86846 2.500	22,005
240	24,00-25,99	25,000	28,000	128,000	56,000	26,000	86843 5.001	86846 2.500	24,000
240	24,00-25,99	25,400	28,000	128,000	56,000	26,000	86843 5.001	86846 2.500	24,005
260	26,00-27,99	32,000	32,000	142,000	60,000	28,000	86843 5.003	86846 2.500	26,000
260	26,00-27,99	31,750	32,000	142,000	60,000	28,000	86843 5.003	86846 2.500	26,005
280	28,00-29,99	32,000	34,000	147,000	60,000	30,000	86843 5.003	86846 2.500	28,000
280	28,00-29,99	31,750	34,000	147,000	60,000	30,000	86843 5.003	86846 2.500	28,005
300	30,00-31,99	32,000	38,000	152,000	60,000	32,000	86843 6.000	86846 4.006	30,000
300	30,00-31,99	31,750	38,000	152,000	60,000	32,000	86843 6.000	86846 4.006	30,005
320	32,00-35,99	32,000	42,000	163,000	60,000	36,000	86843 6.001	86846 4.006	32,000
320	32,00-35,99	31,750	42,000	163,000	60,000	36,000	86843 6.001	86846 4.006	32,005
360	36,00-40,00	32,000	46,000	173,000	60,000	40,000	86843 6.002	86846 4.006	36,000
360	36,00-40,00	31,750	46,000	173,000	60,000	40,000	86843 6.002	86846 4.006	36,005



Plaquettes interchangeables Multiplex HPC

N° d'article 86722



P	M	K	N	S	H
●	○	○			



Amin. de l'âme $\geq \varnothing 11,000$ • affûtage en pente • forme de l'arête de coupe principale, rectiligne, (obtenue par correction) • vis de serrage n°86843 incluse

aciers de construction et de cémentation • aciers de décolletage, aciers d'amélioration • aciers alliés jusqu'à 1200 N/mm²

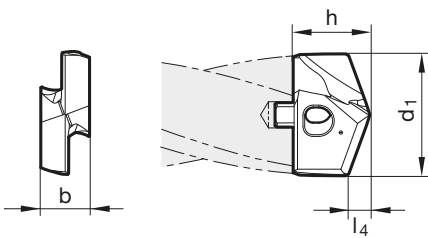

Taille	d1 mm	inch	l4 mm	b mm	h mm	N° de code
110	11,000		2,100	4,500	7,500	11,000
110	11,200		2,100	4,500	7,500	11,200
115	11,500		2,100	4,500	7,500	11,500
115	11,510	29/64	2,100	4,500	7,500	11,510
115	11,700		2,200	4,500	7,500	11,700
115	11,800		2,200	4,500	7,500	11,800
115	11,910	15/32	2,200	4,500	7,500	11,910
120	12,000		2,200	5,000	7,700	12,000
120	12,100		2,300	5,000	7,700	12,100
120	12,200		2,300	5,000	7,700	12,200
120	12,300	31/64	2,300	5,000	7,700	12,300
125	12,500		2,300	5,000	7,700	12,500
125	12,600		2,300	5,000	7,700	12,600
125	12,700	1/2	2,400	5,000	7,700	12,700
125	12,800		2,400	5,000	7,700	12,800
125	12,900		2,400	5,000	7,700	12,900
130	13,000		2,400	5,500	8,500	13,000
130	13,100	33/64	2,400	5,500	8,500	13,100
130	13,490	17/32	2,500	5,500	8,500	13,490
135	13,500		2,500	5,500	8,500	13,500
135	13,600		2,500	5,500	8,500	13,600
135	13,700		2,500	5,500	8,500	13,700
135	13,800		2,600	5,500	8,500	13,800
135	13,890	35/64	2,600	5,500	8,500	13,890
140	14,000		2,600	6,000	9,600	14,000
140	14,100		2,600	6,000	9,600	14,100
140	14,290	9/16	2,700	6,000	9,600	14,290
140	14,400		2,700	6,000	9,600	14,400
145	14,500		2,700	6,000	9,600	14,500
145	14,600		2,700	6,000	9,600	14,600
145	14,680	37/64	2,700	6,000	9,600	14,680
145	14,700		2,700	6,000	9,600	14,700
145	14,800		2,700	6,000	9,600	14,800
150	15,000		2,800	6,000	9,800	15,000
150	15,080	19/32	2,800	6,000	9,800	15,080
150	15,100		2,800	6,000	9,800	15,100
150	15,200		2,800	6,000	9,800	15,200
150	15,300		2,800	6,000	9,800	15,300
150	15,480	39/64	2,900	6,000	9,800	15,480
155	15,500		2,900	6,000	9,800	15,500
155	15,600		2,900	6,000	9,800	15,600
155	15,700		2,900	6,000	9,800	15,700



Plaquettes interchangeables Multiplex HPC

Taille	d1 mm	inch	l4 mm	b mm	h mm	N° de code
155	15,800		2,900	6,000	9,800	15,800
155	15,870	5/8	2,900	6,000	9,800	15,870
160	16,000		3,000	7,000	11,000	16,000
160	16,270	41/64	3,000	7,000	11,000	16,270
165	16,500		3,100	7,000	11,000	16,500
165	16,670	21/32	3,100	7,000	11,000	16,670
170	17,000		3,100	7,000	11,000	17,000
170	17,070	43/64	3,200	7,000	11,000	17,070
170	17,460	11/16	3,200	7,000	11,000	17,460
175	17,500		3,200	7,000	11,000	17,500
175	17,600		3,300	7,000	11,000	17,600
175	17,860	45/64	3,300	7,000	11,000	17,860
180	18,000		3,300	8,000	12,600	18,000
180	18,260	23/32	3,400	8,000	12,600	18,260
185	18,500		3,400	8,000	12,600	18,500
185	18,650	47/64	3,400	8,000	12,600	18,650
190	19,000		3,500	8,000	12,600	19,000
190	19,050	3/4	3,500	8,000	12,600	19,050
190	19,250		3,600	8,000	12,600	19,250
190	19,450	49/64	3,600	8,000	12,600	19,450
195	19,500		3,600	8,000	12,600	19,500
195	19,600		3,600	8,000	12,600	19,600
195	19,840	25/32	3,700	8,000	12,600	19,840
200	20,000		3,700	9,000	13,900	20,000
200	20,240	51/64	3,700	9,000	13,900	20,240
205	20,500		3,800	9,000	13,900	20,500
205	20,640	13/16	3,800	9,000	13,900	20,640
210	21,000		3,900	9,000	13,900	21,000
210	21,030	53/64	3,900	9,000	13,900	21,030
210	21,100		3,900	9,000	13,900	21,100
210	21,430	27/32	3,900	9,000	13,900	21,430
215	21,500		4,000	9,000	13,900	21,500
215	21,830	55/64	4,000	9,000	13,900	21,830
220	22,000		4,100	10,000	15,300	22,000
220	22,220	7/8	4,100	10,000	15,300	22,220
225	22,500		4,100	10,000	15,300	22,500
225	22,620	57/64	4,200	10,000	15,300	22,620
230	23,000		4,200	10,000	15,300	23,000
230	23,020	29/32	4,200	10,000	15,300	23,020
230	23,420	59/64	4,300	10,000	15,300	23,420
235	23,500		4,300	10,000	15,300	23,500
235	23,810	15/16	4,400	10,000	15,300	23,810
240	24,000		4,400	11,000	15,800	24,000
240	24,100		4,400	11,000	15,800	24,100
240	24,210	61/64	4,500	11,000	15,800	24,210
245	24,500		4,500	11,000	15,800	24,500
245	24,610	31/32	4,500	11,000	15,800	24,610
250	25,000	63/64	4,600	11,000	15,800	25,000
250	25,400	1	4,700	11,000	15,800	25,400
255	25,500		4,700	11,000	15,800	25,500
255	25,670		4,700	11,000	15,800	25,670
255	25,700		4,700	11,000	15,800	25,700
255	25,810		4,700	11,000	15,800	25,810
260	26,000		4,800	12,000	20,000	26,000
260	26,190	1 1/32	4,800	12,000	20,000	26,190
265	26,500		4,900	12,000	20,000	26,500
265	26,590	1 3/64	4,900	12,000	20,000	26,590
270	27,000		5,000	12,000	20,000	27,000
275	27,500		5,100	12,000	20,000	27,500
275	27,700		5,100	12,000	20,000	27,700
275	27,780	1 3/32	5,100	12,000	20,000	27,780
280	28,000		5,100	13,000	20,700	28,000
280	28,180	1 7/64	5,200	13,000	20,700	28,180
285	28,500		5,200	13,000	20,700	28,500
285	28,580		5,300	13,000	20,700	28,580
290	29,000		5,300	13,000	20,700	29,000
290	29,370	1 5/32	5,400	13,000	20,700	29,370
295	29,500		5,400	13,000	20,700	29,500
295	29,770	1 11/64	5,500	13,000	20,700	29,770
300	30,000		5,500	14,000	22,300	30,000
300	30,160	1 3/16	5,500	14,000	22,300	30,160
305	30,500		5,600	14,000	22,300	30,500



Plaquettes interchangeables Multiplex HPC

Taille	d1 mm	inch	l4 mm	b mm	h mm	N° de code
305	30,960	1 7/32	5,700	14,000	22,300	30,960
310	31,000		5,700	14,000	22,300	31,000
315	31,500		5,800	14,000	22,300	31,500
315	31,750	1 1/4	5,800	14,000	22,300	31,750
320	32,000		5,900	15,000	23,100	32,000
320	32,500		6,000	15,000	23,100	32,500
320	32,540	1 9/32	6,000	15,000	23,100	32,540
320	32,940	1 19/64	6,000	15,000	23,100	32,940
330	33,000		6,100	15,000	23,100	33,000
330	33,340	1 5/16	6,100	15,000	23,100	33,340
330	33,500		6,100	15,000	23,100	33,500
340	34,000		6,200	15,000	23,100	34,000
340	34,130	1 11/32	6,300	15,000	23,100	34,130
340	34,500		6,300	15,000	23,100	34,500
340	34,930		6,400	15,000	23,100	34,930
350	35,000		6,400	15,000	23,100	35,000
350	35,500		6,500	15,000	23,100	35,500
350	35,720	1 13/32	6,600	15,000	23,100	35,720
360	36,000		6,600	16,000	23,900	36,000
360	36,500		6,700	16,000	23,900	36,500
360	36,510	1 7/16	6,700	16,000	23,900	36,510
370	37,000		6,800	16,000	23,900	37,000
370	37,310	1 15/32	6,800	16,000	23,900	37,310
370	37,500		6,900	16,000	23,900	37,500
380	38,000		7,000	16,000	23,900	38,000
380	38,100	1 1/2	7,000	16,000	23,900	38,100
380	38,500	1 33/64	7,100	16,000	23,900	38,500
390	39,000		7,100	16,000	23,900	39,000
390	39,500		7,200	16,000	23,900	39,500
400	40,000		7,300	16,000	23,900	40,000



EXEMPLE D'APPLICATION BRIDE EN ACIER

Type d'outil	Multiplex HPC
N° d'article WP	86722
N° d'article support	86683
Diamètre	26 mm
Profondeur	80 mm
Matériau	36NiCrMo6
Refroidissement	RI 20 bar
Lubrifiant	Èmulsion
Machine	Centre de traitement
v_c	100 m/min
f	0,4 mm/rotation
Tenue de coupe	40 m



HARTNER

Plaquettes interchangeables Multiplex HPC

N° d'article 86725



P	M	K	N	S	H
○	●			○	○



Amin. de l'âme $\geq \varnothing 11,000$ • affûtage à dépouille conique • forme de l'arête de coupe principale, rectiligne, (obtenue par correction) • vis de serrage n°86843 incluse
aciers inoxydables

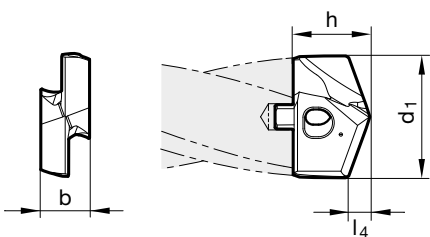

Taille	d1 mm	inch	l4 mm	b mm	h mm	N° de code
110	11,000		2,100	4,500	7,500	11,000
110	11,200		2,100	4,500	7,500	11,200
115	11,500		2,100	4,500	7,500	11,500
115	11,510	29/64	2,100	4,500	7,500	11,510
115	11,700		2,200	4,500	7,500	11,700
115	11,800		2,200	4,500	7,500	11,800
115	11,910	15/32	2,200	4,500	7,500	11,910
120	12,000		2,200	5,000	7,700	12,000
120	12,100		2,300	5,000	7,700	12,100
120	12,200		2,300	5,000	7,700	12,200
120	12,300	31/64	2,300	5,000	7,700	12,300
125	12,500		2,300	5,000	7,700	12,500
125	12,600		2,300	5,000	7,700	12,600
125	12,700	1/2	2,400	5,000	7,700	12,700
125	12,800		2,400	5,000	7,700	12,800
125	12,900		2,400	5,000	7,700	12,900
130	13,000		2,400	5,500	8,500	13,000
130	13,100	33/64	2,400	5,500	8,500	13,100
130	13,490	17/32	2,500	5,500	8,500	13,490
135	13,500		2,500	5,500	8,500	13,500
135	13,600		2,500	5,500	8,500	13,600
135	13,700		2,500	5,500	8,500	13,700
135	13,800		2,600	5,500	8,500	13,800
135	13,890	35/64	2,600	5,500	8,500	13,890
140	14,000		2,600	6,000	9,600	14,000
140	14,100		2,600	6,000	9,600	14,100
140	14,290	9/16	2,700	6,000	9,600	14,290
140	14,400		2,700	6,000	9,600	14,400
145	14,500		2,700	6,000	9,600	14,500
145	14,600		2,700	6,000	9,600	14,600
145	14,700		2,700	6,000	9,600	14,700
145	14,800		2,700	6,000	9,600	14,800
150	15,000		2,800	6,000	9,800	15,000
150	15,080	19/32	2,800	6,000	9,800	15,080
150	15,100		2,800	6,000	9,800	15,100
150	15,200		2,800	6,000	9,800	15,200
150	15,300		2,800	6,000	9,800	15,300
155	15,500		2,900	6,000	9,800	15,500
155	15,600		2,900	6,000	9,800	15,600
155	15,700		2,900	6,000	9,800	15,700
155	15,800		2,900	6,000	9,800	15,800
155	15,870	5/8	2,900	6,000	9,800	15,870



Plaquettes interchangeables Multiplex HPC

Taille	d1 mm	inch	l4 mm	b mm	h mm	N° de code
160	16,000		3,000	7,000	11,000	16,000
160	16,270	41/64	3,000	7,000	11,000	16,270
165	16,500		3,100	7,000	11,000	16,500
165	16,670	21/32	3,100	7,000	11,000	16,670
170	17,000		3,100	7,000	11,000	17,000
170	17,070	43/64	3,200	7,000	11,000	17,070
170	17,460	11/16	3,200	7,000	11,000	17,460
175	17,500		3,200	7,000	11,000	17,500
175	17,600		3,300	7,000	11,000	17,600
175	17,860	45/64	3,300	7,000	11,000	17,860
180	18,000		3,300	8,000	12,600	18,000
180	18,260	23/32	3,400	8,000	12,600	18,260
185	18,500		3,400	8,000	12,600	18,500
185	18,650	47/64	3,400	8,000	12,600	18,650
190	19,000		3,500	8,000	12,600	19,000
190	19,050	3/4	3,500	8,000	12,600	19,050
190	19,450	49/64	3,600	8,000	12,600	19,450
195	19,500		3,600	8,000	12,600	19,500
195	19,600		3,600	8,000	12,600	19,600
195	19,840	25/32	3,700	8,000	12,600	19,840
200	20,000		3,700	9,000	13,900	20,000
200	20,240	51/64	3,700	9,000	13,900	20,240
205	20,500		3,800	9,000	13,900	20,500
205	20,640	13/16	3,800	9,000	13,900	20,640
210	21,000		3,900	9,000	13,900	21,000
210	21,030	53/64	3,900	9,000	13,900	21,030
210	21,100		3,900	9,000	13,900	21,100
210	21,430	27/32	3,900	9,000	13,900	21,430
215	21,500		4,000	9,000	13,900	21,500
215	21,830	55/64	4,000	9,000	13,900	21,830
220	22,000		4,100	10,000	15,300	22,000
220	22,220	7/8	4,100	10,000	15,300	22,220
225	22,500		4,100	10,000	15,300	22,500
225	22,620	57/64	4,200	10,000	15,300	22,620
230	23,000		4,200	10,000	15,300	23,000
230	23,020	29/32	4,200	10,000	15,300	23,020
230	23,420	59/64	4,300	10,000	15,300	23,420
235	23,500		4,300	10,000	15,300	23,500
235	23,810	15/16	4,400	10,000	15,300	23,810
240	24,000		4,400	11,000	15,800	24,000
240	24,100		4,400	11,000	15,800	24,100
240	24,210	61/64	4,500	11,000	15,800	24,210
245	24,500		4,500	11,000	15,800	24,500
245	24,610	31/32	4,500	11,000	15,800	24,610
250	25,000	63/64	4,600	11,000	15,800	25,000
250	25,400	1	4,700	11,000	15,800	25,400
255	25,500		4,700	11,000	15,800	25,500
255	25,670		4,700	11,000	15,800	25,670
255	25,700		4,700	11,000	15,800	25,700
260	26,000		4,800	12,000	20,000	26,000
260	26,190	1 1/32	4,800	12,000	20,000	26,190
265	26,500		4,900	12,000	20,000	26,500
265	26,590	1 3/64	4,900	12,000	20,000	26,590
270	27,000		5,000	12,000	20,000	27,000
275	27,500		5,100	12,000	20,000	27,500
275	27,700		5,100	12,000	20,000	27,700
275	27,780	1 3/32	5,100	12,000	20,000	27,780
280	28,000		5,100	13,000	20,700	28,000
280	28,180	1 7/64	5,200	13,000	20,700	28,180
285	28,500		5,200	13,000	20,700	28,500
285	28,580		5,300	13,000	20,700	28,580
290	29,000		5,300	13,000	20,700	29,000
290	29,370	1 5/32	5,400	13,000	20,700	29,370
295	29,500		5,400	13,000	20,700	29,500
295	29,600		5,400	13,000	20,700	29,600
295	29,770	1 11/64	5,500	13,000	20,700	29,770
300	30,000		5,500	14,000	22,300	30,000
300	30,160	1 3/16	5,500	14,000	22,300	30,160
305	30,500		5,600	14,000	22,300	30,500
305	30,960	1 7/32	5,700	14,000	22,300	30,960
310	31,000		5,700	14,000	22,300	31,000
315	31,500		5,800	14,000	22,300	31,500



Plaquettes interchangeables Multiplex HPC

Taille	d1 mm	inch	l4 mm	b mm	h mm	N° de code
315	31,750	1 1/4	5,800	14,000	22,300	31,750
320	32,000		5,900	15,000	23,100	32,000
320	32,500		6,000	15,000	23,100	32,500
320	32,540	1 9/32	6,000	15,000	23,100	32,540
320	32,940	1 19/64	6,000	15,000	23,100	32,940
330	33,000		6,100	15,000	23,100	33,000
330	33,340	1 5/16	6,100	15,000	23,100	33,340
330	33,500		6,100	15,000	23,100	33,500
340	34,000		6,200	15,000	23,100	34,000
340	34,130	1 11/32	6,300	15,000	23,100	34,130
340	34,500		6,300	15,000	23,100	34,500
340	34,930		6,400	15,000	23,100	34,930
350	35,000		6,400	15,000	23,100	35,000
350	35,500		6,500	15,000	23,100	35,500
350	35,720	1 13/32	6,600	15,000	23,100	35,720
360	36,000		6,600	16,000	23,900	36,000
360	36,500		6,700	16,000	23,900	36,500
360	36,510	1 7/16	6,700	16,000	23,900	36,510
370	37,000		6,800	16,000	23,900	37,000
370	37,310	1 15/32	6,800	16,000	23,900	37,310
370	37,500		6,900	16,000	23,900	37,500
380	38,000		7,000	16,000	23,900	38,000
380	38,100	1 1/2	7,000	16,000	23,900	38,100
380	38,500	1 33/64	7,100	16,000	23,900	38,500
390	39,000		7,100	16,000	23,900	39,000
390	39,500		7,200	16,000	23,900	39,500
400	40,000		7,300	16,000	23,900	40,000



EXEMPLE D'APPLICATION BRIDE EN ACIER INOXYDABLE

Type d'outil	Multiplex HPC
N° d'article plaq. interch.	86725
N° d'article support	86684
Diamètre	17 mm
Profondeur	90 mm
Matériau	X6CrNiMoTi 17-12-2
Refroidissement	RI 40 bar
Lubrifiant	Èmulsion
Machine	Centre de traitement
v_c	40 m/min
f	0,15 mm/rotation
Tenue de coupe	22,5 m



Plaquettes interchangeables Multiplex HPC

N° d'article 86723



P	M	K	N	S	H
○		●			



Amin. de l'âme $\geq \varnothing 11,000$ • affûtage en pente • forme de l'arête de coupe principale, rectiligne, (obtenue par correction) • vis de serrage n°86843 incluse

fontes vermiculaires GGV • fontes grises, fontes malléables, fontes à graphite sphéroïdal

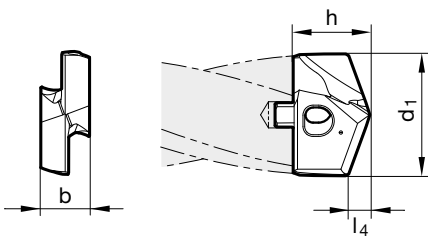

Taille	d1 mm	inch	l4 mm	b mm	h mm	N° de code
110	11,000		2,600	4,500	7,500	11,000
110	11,200		2,600	4,500	7,500	11,200
115	11,500		2,700	4,500	7,500	11,500
115	11,510	29/64	2,700	4,500	7,500	11,510
115	11,700		2,700	4,500	7,500	11,700
115	11,800		2,700	4,500	7,500	11,800
115	11,910	15/32	2,700	4,500	7,500	11,910
120	12,000		2,900	5,000	7,700	12,000
120	12,100		2,900	5,000	7,700	12,100
120	12,200		2,900	5,000	7,700	12,200
120	12,300	31/64	2,900	5,000	7,700	12,300
125	12,500		3,000	5,000	7,700	12,500
125	12,600		3,000	5,000	7,700	12,600
125	12,700	1/2	3,000	5,000	7,700	12,700
125	12,800		3,000	5,000	7,700	12,800
125	12,900		3,000	5,000	7,700	12,900
130	13,000		3,100	5,500	8,500	13,000
130	13,100	33/64	3,100	5,500	8,500	13,100
130	13,490	17/32	3,100	5,500	8,500	13,490
135	13,500		3,300	5,500	8,500	13,500
135	13,600		3,300	5,500	8,500	13,600
135	13,700		3,300	5,500	8,500	13,700
135	13,800		3,300	5,500	8,500	13,800
135	13,890	35/64	3,300	5,500	8,500	13,890
140	14,000		3,400	6,000	9,600	14,000
140	14,100		3,400	6,000	9,600	14,100
140	14,290	9/16	3,400	6,000	9,600	14,290
140	14,400		3,400	6,000	9,600	14,400
145	14,500		3,500	6,000	9,600	14,500
145	14,600		3,500	6,000	9,600	14,600
145	14,680	37/64	3,500	6,000	9,600	14,680
145	14,700		3,500	6,000	9,600	14,700
145	14,800		3,500	6,000	9,600	14,800
150	15,000		3,600	6,000	9,800	15,000
150	15,080	19/32	3,600	6,000	9,800	15,080
150	15,100		3,600	6,000	9,800	15,100
150	15,200		3,600	6,000	9,800	15,200
150	15,300		3,600	6,000	9,800	15,300
150	15,480	39/64	3,600	6,000	9,800	15,480
155	15,500		3,800	6,000	9,800	15,500
155	15,600		3,800	6,000	9,800	15,600
155	15,700		3,800	6,000	9,800	15,700



Plaquettes interchangeables Multiplex HPC

Taille	d1 mm	inch	l4 mm	b mm	h mm	N° de code
155	15,800		3,800	6,000	9,800	15,800
155	15,870	5/8	3,800	6,000	9,800	15,870
160	16,000		3,800	7,000	11,000	16,000
160	16,270	41/64	3,800	7,000	11,000	16,270
165	16,500		4,000	7,000	11,000	16,500
165	16,670	21/32	4,000	7,000	11,000	16,670
170	17,000		4,100	7,000	11,000	17,000
170	17,070	43/64	4,100	7,000	11,000	17,070
170	17,460	11/16	4,100	7,000	11,000	17,460
175	17,500		4,200	7,000	11,000	17,500
175	17,600		4,200	7,000	11,000	17,600
175	17,860	45/64	4,200	7,000	11,000	17,860
180	18,000		4,300	8,000	12,600	18,000
180	18,260	23/32	4,300	8,000	12,600	18,260
185	18,500		4,400	8,000	12,600	18,500
185	18,650	47/64	4,400	8,000	12,600	18,650
190	19,000		4,600	8,000	12,600	19,000
190	19,050	3/4	4,600	8,000	12,600	19,050
190	19,250		4,600	8,000	12,600	19,250
190	19,450	49/64	4,600	8,000	12,600	19,450
195	19,500		4,700	8,000	12,600	19,500
195	19,600		4,700	8,000	12,600	19,600
195	19,840	25/32	4,700	8,000	12,600	19,840
200	20,000		4,800	9,000	13,900	20,000
200	20,240	51/64	4,800	9,000	13,900	20,240
205	20,500		5,000	9,000	13,900	20,500
205	20,640	13/16	5,000	9,000	13,900	20,640
210	21,000		5,100	9,000	13,900	21,000
210	21,030	53/64	5,100	9,000	13,900	21,030
210	21,100		5,100	9,000	13,900	21,100
210	21,430	27/32	5,100	9,000	13,900	21,430
215	21,500		5,200	9,000	13,900	21,500
215	21,830	55/64	5,200	9,000	13,900	21,830
220	22,000		5,300	10,000	15,300	22,000
220	22,220	7/8	5,300	10,000	15,300	22,220
225	22,500		5,400	10,000	15,300	22,500
225	22,620	57/64	5,400	10,000	15,300	22,620
230	23,000		5,600	10,000	15,300	23,000
230	23,020	29/32	5,600	10,000	15,300	23,020
230	23,420	59/64	5,600	10,000	15,300	23,420
235	23,500		5,700	10,000	15,300	23,500
235	23,810	15/16	5,700	10,000	15,300	23,810
240	24,000		5,800	11,000	15,800	24,000
240	24,100		5,800	11,000	15,800	24,100
240	24,210	61/64	5,800	11,000	15,800	24,210
245	24,500		6,000	11,000	15,800	24,500
245	24,610	31/32	6,000	11,000	15,800	24,610
250	25,000	63/64	6,100	11,000	15,800	25,000
250	25,400	1	6,100	11,000	15,800	25,400
255	25,500		6,200	11,000	15,800	25,500
255	25,670		6,200	11,000	15,800	25,670
255	25,700		6,200	11,000	15,800	25,700
255	25,810		6,200	11,000	15,800	25,810
260	26,000		6,000	12,000	20,000	26,000
260	26,190	1 1/32	6,000	12,000	20,000	26,190
265	26,500		6,100	12,000	20,000	26,500
265	26,590	1 3/64	6,100	12,000	20,000	26,590
270	27,000		6,300	12,000	20,000	27,000
275	27,500		6,400	12,000	20,000	27,500
275	27,700		6,400	12,000	20,000	27,700
275	27,780	1 3/32	6,400	12,000	20,000	27,780
280	28,000		6,600	13,000	20,700	28,000
280	28,180	1 7/64	6,600	13,000	20,700	28,180
285	28,500		6,700	13,000	20,700	28,500
285	28,580		6,700	13,000	20,700	28,580
290	29,000		6,900	13,000	20,700	29,000
290	29,370	1 5/32	6,900	13,000	20,700	29,370
295	29,500		7,000	13,000	20,700	29,500
295	29,770	1 11/64	7,000	13,000	20,700	29,770
300	30,000		6,900	14,000	22,300	30,000
300	30,160	1 3/16	6,900	14,000	22,300	30,160
305	30,500		7,000	14,000	22,300	30,500



Plaquettes interchangeables Multiplex HPC

Taille	d1 mm	inch	l4 mm	b mm	h mm	N° de code
305	30,960	1 7/32	7,000	14,000	22,300	30,960
310	31,000		7,200	14,000	22,300	31,000
315	31,500		7,300	14,000	22,300	31,500
315	31,750	1 1/4	7,300	14,000	22,300	31,750
320	32,000		7,500	15,000	23,100	32,000
320	32,500		7,600	15,000	23,100	32,500
320	32,540	1 9/32	7,600	15,000	23,100	32,540
320	32,940	1 19/64	7,600	15,000	23,100	32,940
330	33,000		7,800	15,000	23,100	33,000
330	33,340	1 5/16	7,800	15,000	23,100	33,340
330	33,500		7,900	15,000	23,100	33,500
340	34,000		8,100	15,000	23,100	34,000
340	34,130	1 11/32	8,100	15,000	23,100	34,130
340	34,500		8,200	15,000	23,100	34,500
340	34,930		8,200	15,000	23,100	34,930
350	35,000		8,300	15,000	23,100	35,000
350	35,500		8,400	15,000	23,100	35,500
350	35,720	1 13/32	8,400	15,000	23,100	35,720
360	36,000		8,500	16,000	23,900	36,000
360	36,500		8,600	16,000	23,900	36,500
360	36,510	1 7/16	8,600	16,000	23,900	36,510
370	37,000		8,800	16,000	23,900	37,000
370	37,310	1 15/32	8,800	16,000	23,900	37,310
370	37,500		8,900	16,000	23,900	37,500
380	38,000		9,000	16,000	23,900	38,000
380	38,100	1 1/2	9,000	16,000	23,900	38,100
380	38,500	1 33/64	9,100	16,000	23,900	38,500
390	39,000		9,300	16,000	23,900	39,000
390	39,500		9,400	16,000	23,900	39,500
400	40,000		9,400	16,000	23,900	40,000



EXEMPLE D'APPLICATION CARTER EN FONTE

Type d'outil	Multiplex HPC
N° d'article plaq. interch.	86723
N° d'article Support	86684
Diamètre	22 mm
Profondeur	110 mm
Matériau	EN-GJL-250
Refroidissement	RI 60 bar
Lubrifiant	Èmulsion
Machine	Centre de traitement
v_c	90 m/min
f	0,5 mm/rotation
Tenue de coupe	350 m



Plaquettes interchangeables Multiplex HPC

N° d'article 86724



P	M	K	N	S	H
			•		



Amin. de l'âme $\geq \varnothing 11,000$ • affûtage à dépouille conique • vis de serrage n°86843 incluse • forme concave de l'arête de coupe principale

aluminium et alliages d'aluminium • métaux non ferreux

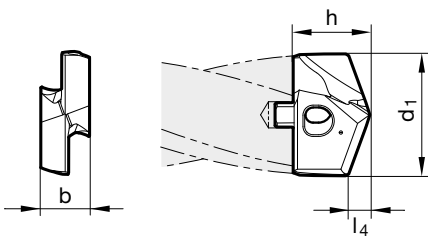

Taille	d1 mm	inch	l4 mm	b mm	h mm	N° de code
110	11,000		2,100	4,500	7,500	11,000
110	11,200		2,100	4,500	7,500	11,200
115	11,500		2,100	4,500	7,500	11,500
115	11,510	29/64	2,100	4,500	7,500	11,510
115	11,700		2,200	4,500	7,500	11,700
115	11,800		2,200	4,500	7,500	11,800
115	11,910	15/32	2,200	4,500	7,500	11,910
120	12,000		2,200	5,000	7,700	12,000
120	12,100		2,300	5,000	7,700	12,100
120	12,200		2,300	5,000	7,700	12,200
120	12,300	31/64	2,300	5,000	7,700	12,300
125	12,500		2,300	5,000	7,700	12,500
125	12,600		2,300	5,000	7,700	12,600
125	12,700	1/2	2,400	5,000	7,700	12,700
125	12,800		2,400	5,000	7,700	12,800
125	12,900		2,400	5,000	7,700	12,900
130	13,000		2,400	5,500	8,500	13,000
130	13,100	33/64	2,400	5,500	8,500	13,100
130	13,490	17/32	2,500	5,500	8,500	13,490
135	13,500		2,500	5,500	8,500	13,500
135	13,600		2,500	5,500	8,500	13,600
135	13,700		2,500	5,500	8,500	13,700
135	13,800		2,600	5,500	8,500	13,800
135	13,890	35/64	2,600	5,500	8,500	13,890
140	14,000		2,600	6,000	9,600	14,000
140	14,100		2,600	6,000	9,600	14,100
140	14,290	9/16	2,700	6,000	9,600	14,290
140	14,400		2,700	6,000	9,600	14,400
145	14,500		2,700	6,000	9,600	14,500
145	14,600		2,700	6,000	9,600	14,600
145	14,680	37/64	2,700	6,000	9,600	14,680
145	14,700		2,700	6,000	9,600	14,700
145	14,800		2,700	6,000	9,600	14,800
150	15,000		2,800	6,000	9,800	15,000
150	15,080	19/32	2,800	6,000	9,800	15,080
150	15,100		2,800	6,000	9,800	15,100
150	15,200		2,800	6,000	9,800	15,200
150	15,300		2,800	6,000	9,800	15,300
150	15,480	39/64	2,900	6,000	9,800	15,480
155	15,500		2,900	6,000	9,800	15,500
155	15,600		2,900	6,000	9,800	15,600
155	15,700		2,900	6,000	9,800	15,700



Plaquettes interchangeables Multiplex HPC

Taille	d1 mm	inch	l4 mm	b mm	h mm	N° de code
155	15,800		2,900	6,000	9,800	15,800
155	15,870	5/8	2,900	6,000	9,800	15,870
160	16,000		3,000	7,000	11,000	16,000
160	16,270	41/64	3,000	7,000	11,000	16,270
165	16,500		3,100	7,000	11,000	16,500
165	16,670	21/32	3,100	7,000	11,000	16,670
170	17,000		3,100	7,000	11,000	17,000
170	17,070	43/64	3,200	7,000	11,000	17,070
170	17,460	11/16	3,200	7,000	11,000	17,460
175	17,500		3,200	7,000	11,000	17,500
175	17,600		3,300	7,000	11,000	17,600
175	17,860	45/64	3,300	7,000	11,000	17,860
180	18,000		3,300	8,000	12,600	18,000
180	18,260	23/32	3,400	8,000	12,600	18,260
185	18,500		3,400	8,000	12,600	18,500
185	18,650	47/64	3,400	8,000	12,600	18,650
190	19,000		3,500	8,000	12,600	19,000
190	19,050	3/4	3,500	8,000	12,600	19,050
190	19,250		3,600	8,000	12,600	19,250
190	19,450	49/64	3,600	8,000	12,600	19,450
195	19,500		3,600	8,000	12,600	19,500
195	19,600		3,600	8,000	12,600	19,600
195	19,840	25/32	3,700	8,000	12,600	19,840
200	20,000		3,700	9,000	13,900	20,000
200	20,240	51/64	3,700	9,000	13,900	20,240
205	20,500		3,800	9,000	13,900	20,500
205	20,640	13/16	3,800	9,000	13,900	20,640
210	21,000		3,900	9,000	13,900	21,000
210	21,030	53/64	3,900	9,000	13,900	21,030
210	21,100		3,900	9,000	13,900	21,100
210	21,430	27/32	3,900	9,000	13,900	21,430
215	21,500		4,000	9,000	13,900	21,500
215	21,830	55/64	4,000	9,000	13,900	21,830
220	22,000		4,100	10,000	15,300	22,000
220	22,220	7/8	4,100	10,000	15,300	22,220
225	22,500		4,100	10,000	15,300	22,500
225	22,620	57/64	4,200	10,000	15,300	22,620
230	23,000		4,200	10,000	15,300	23,000
230	23,020	29/32	4,200	10,000	15,300	23,020
230	23,420	59/64	4,300	10,000	15,300	23,420
235	23,500		4,300	10,000	15,300	23,500
235	23,810	15/16	4,400	10,000	15,300	23,810
240	24,000		4,400	11,000	15,800	24,000
240	24,100		4,400	11,000	15,800	24,100
240	24,210	61/64	4,500	11,000	15,800	24,210
245	24,500		4,500	11,000	15,800	24,500
245	24,610	31/32	4,500	11,000	15,800	24,610
250	25,000	63/64	4,600	11,000	15,800	25,000
250	25,400	1	4,700	11,000	15,800	25,400
255	25,500		4,700	11,000	15,800	25,500
255	25,670		4,700	11,000	15,800	25,670
255	25,700		4,700	11,000	15,800	25,700
255	25,810		4,700	11,000	15,800	25,810
260	26,000		4,800	12,000	20,000	26,000
260	26,190	1 1/32	4,800	12,000	20,000	26,190
265	26,500		4,900	12,000	20,000	26,500
265	26,590	1 3/64	4,900	12,000	20,000	26,590
270	27,000		5,000	12,000	20,000	27,000
275	27,500		5,100	12,000	20,000	27,500
275	27,700		5,100	12,000	20,000	27,700
275	27,780	1 3/32	5,100	12,000	20,000	27,780
280	28,000		5,100	13,000	20,700	28,000
280	28,180	1 7/64	5,200	13,000	20,700	28,180
285	28,500		5,200	13,000	20,700	28,500
285	28,580		5,300	13,000	20,700	28,580
290	29,000		5,300	13,000	20,700	29,000
290	29,370	1 5/32	5,400	13,000	20,700	29,370
295	29,500		5,400	13,000	20,700	29,500
295	29,770	1 11/64	5,500	13,000	20,700	29,770
300	30,000		5,500	14,000	22,300	30,000
300	30,160	1 3/16	5,500	14,000	22,300	30,160
305	30,500		5,600	14,000	22,300	30,500



Plaquettes interchangeables Multiplex HPC

Taille	d1 mm	inch	l4 mm	b mm	h mm	N° de code
305	30,960	1 7/32	5,700	14,000	22,300	30,960
310	31,000		5,700	14,000	22,300	31,000
315	31,500		5,800	14,000	22,300	31,500
315	31,750	1 1/4	5,800	14,000	22,300	31,750
320	32,000		5,900	15,000	23,100	32,000
320	32,500		6,000	15,000	23,100	32,500
320	32,540	1 9/32	6,000	15,000	23,100	32,540
320	32,940	1 19/64	6,000	15,000	23,100	32,940
330	33,000		6,100	15,000	23,100	33,000
330	33,340	1 5/16	6,100	15,000	23,100	33,340
330	33,500		6,100	15,000	23,100	33,500
340	34,000		6,200	15,000	23,100	34,000
340	34,130	1 11/32	6,300	15,000	23,100	34,130
340	34,500		6,300	15,000	23,100	34,500
340	34,930		6,400	15,000	23,100	34,930
350	35,000		6,400	15,000	23,100	35,000
350	35,500		6,500	15,000	23,100	35,500
350	35,720	1 13/32	6,600	15,000	23,100	35,720
360	36,000		6,600	16,000	23,900	36,000
360	36,500		6,700	16,000	23,900	36,500
360	36,510	1 7/16	6,700	16,000	23,900	36,510
370	37,000		6,800	16,000	23,900	37,000
370	37,310	1 15/32	6,800	16,000	23,900	37,310
370	37,500		6,900	16,000	23,900	37,500
380	38,000		7,000	16,000	23,900	38,000
380	38,100	1 1/2	7,000	16,000	23,900	38,100
380	38,500	1 33/64	7,100	16,000	23,900	38,500
390	39,000		7,100	16,000	23,900	39,000
390	39,500		7,200	16,000	23,900	39,500
400	40,000		7,300	16,000	23,900	40,000



EXEMPLE D'APPLICATION JANTE EN ALUMINIUM

Type d'outil	Multiplex HPC
N° d'article plaq. interch.	86724
N° d'article Support	86685
Diamètre	13 mm
Profondeur	90 mm
Matériau	G-ALSi7
Refroidissement	RI 40 bar
Lubrifiant	Èmulsion
Machine	Centre de traitement
v_c	140 m/min
f	0,25 mm/rotation
Tenue de coupe	300 m



Plaquettes interchangeables Multiplex HPC

N° d'article 86721



P	M	K	N	S	H
○	○	○	○	○	○



Amin. de l'âme $\geq \varnothing 11,000$ • affûtage en pente • forme de l'arête de coupe principale, rectiligne, (obtenue par correction) • Vis de blocage n°86843 incluse

Pilote de guidage dans tous les matériaux

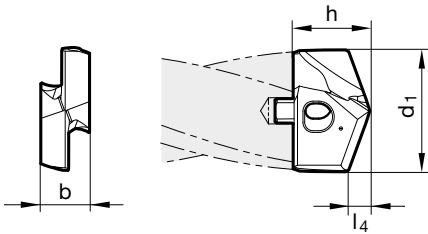

Taille	d1 mm	inch	l4 mm	b mm	h mm	N° de code
110	11,000		1,800	4,500	7,200	11,000
110	11,200		1,800	4,500	7,200	11,200
110	11,500		1,900	4,500	7,200	11,500
110	11,510	29/64	1,900	4,500	7,200	11,510
110	11,700		1,900	4,500	7,200	11,700
110	11,800		1,900	4,500	7,200	11,800
110	11,910	15/32	1,900	4,500	7,200	11,910
120	12,000		1,900	5,000	7,400	12,000
120	12,100		2,000	5,000	7,400	12,100
120	12,200		2,000	5,000	7,400	12,200
120	12,300	31/64	2,000	5,000	7,400	12,300
120	12,500		2,000	5,000	7,400	12,500
120	12,600		2,000	5,000	7,400	12,600
120	12,700	1/2	2,100	5,000	7,400	12,700
120	12,800		2,100	5,000	7,400	12,800
120	12,900		2,100	5,000	7,400	12,900
130	13,000		2,100	5,500	8,200	13,000
130	13,100	33/64	2,100	5,500	8,200	13,100
130	13,490	17/32	2,200	5,500	8,200	13,490
130	13,500		2,200	5,500	8,200	13,500
130	13,600		2,200	5,500	8,200	13,600
130	13,700		2,200	5,500	8,200	13,700
130	13,800		2,200	5,500	8,200	13,800
130	13,890	35/64	2,200	5,500	8,200	13,890
140	14,000		2,300	6,000	9,400	14,000
140	14,100		2,300	6,000	9,400	14,100
140	14,290	9/16	2,300	6,000	9,400	14,290
140	14,400		2,300	6,000	9,400	14,400
140	14,500		2,300	6,000	9,400	14,500
140	14,600		2,400	6,000	9,400	14,600
140	14,680	37/64	2,400	6,000	9,400	14,680
140	14,700		2,400	6,000	9,400	14,700
140	14,800		2,400	6,000	9,400	14,800
140	15,000		2,400	6,000	9,400	15,000
140	15,080	19/32	2,400	6,000	9,400	15,080
140	15,100		2,400	6,000	9,400	15,100
140	15,200		2,400	6,000	9,400	15,200
140	15,300		2,500	6,000	9,400	15,300
140	15,480	39/64	2,500	6,000	9,400	15,480
140	15,500		2,500	6,000	9,400	15,500
140	15,600		2,500	6,000	9,400	15,600
140	15,700		2,500	6,000	9,400	15,700



Plaquettes interchangeables Multiplex HPC

Taille	d1 mm	inch	l4 mm	b mm	h mm	N° de code
140	15,800		2,500	6,000	9,400	15,800
140	15,870	5/8	2,600	6,000	9,400	15,870
160	16,000		2,600	7,000	10,600	16,000
160	16,270	41/64	2,600	7,000	10,600	16,270
160	16,500		2,700	7,000	10,600	16,500
160	16,670	21/32	2,700	7,000	10,600	16,670
160	17,000		2,700	7,000	10,600	17,000
160	17,070	43/64	2,700	7,000	10,600	17,070
160	17,460	11/16	2,800	7,000	10,600	17,460
160	17,500		2,800	7,000	10,600	17,500
160	17,600		2,800	7,000	10,600	17,600
160	17,860	45/64	2,900	7,000	10,600	17,860
180	18,000		2,900	8,000	12,100	18,000
180	18,260	23/32	2,900	8,000	12,100	18,260
180	18,500		3,000	8,000	12,100	18,500
180	18,650	47/64	3,000	8,000	12,100	18,650
180	19,000		3,000	8,000	12,100	19,000
180	19,050	3/4	3,100	8,000	12,100	19,050
180	19,450	49/64	3,100	8,000	12,100	19,450
180	19,500		3,100	8,000	12,100	19,500
180	19,600		3,100	8,000	12,100	19,600
180	19,840	25/32	3,200	8,000	12,100	19,840
200	20,000		3,200	9,000	13,300	20,000
200	20,240	51/64	3,200	9,000	13,300	20,240
200	20,500		3,300	9,000	13,300	20,500
200	20,640	13/16	3,300	9,000	13,300	20,640
200	21,000		3,400	9,000	13,300	21,000
200	21,030	53/64	3,400	9,000	13,300	21,030
200	21,100		3,400	9,000	13,300	21,100
200	21,430	27/32	3,400	9,000	13,300	21,430
200	21,500		3,400	9,000	13,300	21,500
200	21,830	55/64	3,500	9,000	13,300	21,830
220	22,000		3,500	10,000	14,800	22,000
220	22,220	7/8	3,600	10,000	14,800	22,220
220	22,500		3,600	10,000	14,800	22,500
220	22,620	57/64	3,600	10,000	14,800	22,620
220	23,000		3,700	10,000	14,800	23,000
220	23,020	29/32	3,700	10,000	14,800	23,020
220	23,420	59/64	3,700	10,000	14,800	23,420
220	23,500		3,800	10,000	14,800	23,500
220	23,810	15/16	3,800	10,000	14,800	23,810
240	24,000		3,800	11,000	15,300	24,000
240	24,100		3,800	11,000	15,300	24,100
240	24,210	61/64	3,900	11,000	15,300	24,210
240	24,500		3,900	11,000	15,300	24,500
240	24,610	31/32	3,900	11,000	15,300	24,610
240	25,000	63/64	4,000	11,000	15,300	25,000
240	25,400	1	4,100	11,000	15,300	25,400
240	25,500		4,100	11,000	15,300	25,500
240	25,700		4,100	11,000	15,300	25,700
260	26,000		4,100	12,000	19,400	26,000
260	26,190	1 1/32	4,200	12,000	19,400	26,190
260	26,500		4,200	12,000	19,400	26,500
260	26,590	1 3/64	4,200	12,000	19,400	26,590
260	27,000		4,300	12,000	19,400	27,000
260	27,500		4,400	12,000	19,400	27,500
260	27,700		4,400	12,000	19,400	27,700
260	27,780	1 3/32	4,400	12,000	19,400	27,780
280	28,000		4,500	13,000	20,100	28,000
280	28,180	1 7/64	4,500	13,000	20,100	28,180
280	28,500		4,500	13,000	20,100	28,500
280	28,580		4,600	13,000	20,100	28,580
280	29,000		4,600	13,000	20,100	29,000
280	29,370	1 5/32	4,700	13,000	20,100	29,370
280	29,500		4,700	13,000	20,100	29,500
300	30,000		4,800	14,000	21,700	30,000
300	30,160	1 3/16	4,800	14,000	21,700	30,160
300	30,500		4,900	14,000	21,700	30,500
300	30,960	1 7/32	4,900	14,000	21,700	30,960
300	31,000		4,900	14,000	21,700	31,000
300	31,500		5,000	14,000	21,700	31,500
300	31,750	1 1/4	5,100	14,000	21,700	31,750



Plaquettes interchangeables Multiplex HPC

Taille	d1 mm	inch	l4 mm	b mm	h mm	N° de code
320	32,000		5,100	15,000	22,400	32,000
320	32,500		5,200	15,000	22,400	32,500
320	32,540	1 9/32	5,200	15,000	22,400	32,540
320	33,000		5,300	15,000	22,400	33,000
320	33,340	1 5/16	5,300	15,000	22,400	33,340
320	33,500		5,300	15,000	22,400	33,500
320	34,000		5,400	15,000	22,400	34,000
320	34,130	1 11/32	5,400	15,000	22,400	34,130
320	34,500		5,500	15,000	22,400	34,500
320	34,930		5,600	15,000	22,400	34,930
320	35,000		5,600	15,000	22,400	35,000
320	35,500		5,600	15,000	22,400	35,500
320	35,720	1 13/32	5,700	15,000	22,400	35,720
360	36,000		5,700	16,000	23,200	36,000
360	36,500		5,800	16,000	23,200	36,500
360	36,510	1 7/16	5,800	16,000	23,200	36,510
360	37,000		5,900	16,000	23,200	37,000
360	37,310	1 15/32	5,900	16,000	23,200	37,310
360	37,500		6,000	16,000	23,200	37,500
360	38,000		6,000	16,000	23,200	38,000
360	38,100	1 1/2	6,100	16,000	23,200	38,100
360	38,500	1 33/64	6,100	16,000	23,200	38,500
360	39,000		6,200	16,000	23,200	39,000
360	39,500		6,300	16,000	23,200	39,500
360	40,000		6,400	16,000	23,200	40,000



PLAQUETTE PILOTE N° D'ARTICLE 86721

Amincissement spécial de l'âme pour
une amorce de perçage précise

Le double chanfreinage garantit des perçages précis

Angle au sommet à 145° et la tolérance de
diamètre du M7 garantissent des conditions
parfaites pour la plaquette qui suit.

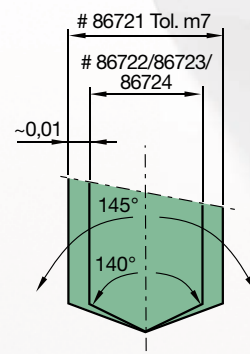



Plaquettes interchangeables Multiplex HPC

N° d'article 86729



P	M	K	N	S	H
•					

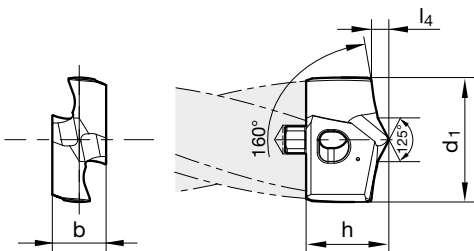
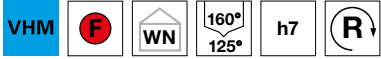

Taille	d1 mm	inch	l4 mm	b mm	h mm	N° de code
120	12,000		1,700	5,000	7,500	12,000
140	14,000		2,000	6,000	9,500	14,000
160	16,000		2,300	7,000	10,800	16,000
180	18,000		2,600	8,000	12,300	18,000
200	20,000		2,900	9,000	13,600	20,000
210	21,000		3,000	9,000	13,600	21,000
220	22,000		3,200	10,000	14,900	22,000
240	24,000		3,500	11,000	15,500	24,000
250	25,000	63/64	3,600	11,000	15,500	25,000
260	26,000		3,800	12,000	18,500	26,000
270	27,000		3,900	12,000	18,600	27,000
280	28,000		4,100	13,000	18,600	28,000
290	29,000		4,200	13,000	18,600	29,000
300	30,000		4,400	14,000	19,900	30,000
320	32,000		4,600	15,000	21,300	32,000
330	33,000		4,800	15,000	21,700	33,000
340	34,000		4,900	15,000	22,200	34,000
360	36,000		5,200	16,000	22,500	36,000
380	38,000		5,500	16,000	23,000	38,000
400	40,000		5,800	16,000	23,100	40,000

MULTIPLIX HPC PLAQUETTES INTERCHANGEABLES POUR L'USINAGE DE POUTRELLES EN ACIER

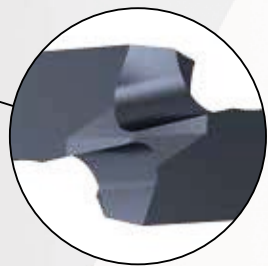

La géométrie d'affûtage des nouvelles plaquettes interchangeables garantit des capacités de centrage optimales et compense ce faisant les conditions d'usinage instables lors de la fabrication des poutrelles en acier.

- ▼ nouvelles plaquettes amovibles spécialement conçues pour l'usinage de poutrelles en acier
- ▼ formation de bavures limitée
- ▼ capacités de centrage optimales
- ▼ perçage silencieux
- ▼ conçu spécialement pour l'usinage sur les installations à scie sabre et à perçage thermique



Formation de bavures minimale grâce à l'angle au sommet élevé à l'extérieur.



Plaquette de lamage Multiplex HPC

N° d'article 86728



P	M	K	N	S	H
•	○	○		○	○



acier, fonte aciérée (alliée / non alliée)

ISO	Taille porte-outils	N° de code
CPGT050202F R-P	110-140	52,020
CPGT050204F R-P	110-140	52,040
CPGT060202F R-P	160-280	62,020
CPGT060204F R-P	160-280	62,040
CPGT09T308F R-P	300-360	93,080



Plaquette de lamage Multiplex HPC

N° d'article 86726



P	M	K	N	S	H
○		●			



fontes grises, fontes malléables, fontes à graphite sphéroïdal

ISO	Taille porte-outils	N° de code
CPGW050202F N-K	110-140	52,020
CPGW050204F N-K	110-140	52,040
CPGW060202F N-K	160-280	62,020
CPGW060204F N-K	160-280	62,040
CPGW09T308F N-K	300-360	93,080



HARTNER

Plaquette de lamage Multiplex HPC

N° d'article 86727



P	M	K	N	S	H
			•		



aluminium et alliages d'aluminium • métaux non ferreux

ISO	Taille porte-outils	N° de code
CPGT050202F R-AL	110-140	52,020
CPGT050204F R-AL	110-140	52,040
CPGT060202F R-AL	160-280	62,020
CPGT060204F R-AL	160-280	62,040
CPGT09T308F R-AL	300-360	93,080



Vis de serrage p. porte-outil de lamage Multiplex HPC

N° d'article 86846



couple de serrage pour vis torx (voir : multiplex HPC technologie et avantages)

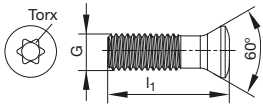

G	l1 mm	Torx	N° de code
M 2,0X5,50	5,500	T6	2,000
M 2,0X5,30	5,300	T7	2,500
M 4 X9,50	9,500	T15	4,006



Vis de serrage p. porte-outils Multiplex HPC 1,5-10xD

N° d'article 86843



couple de serrage pour vis torx (voir : multiplex HPC technologie et avantages)

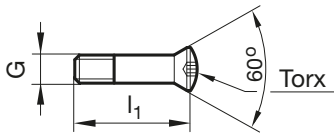

G	l1 mm	Torx	N° de code
M2,2	9,500	T7	2,200
M2,2	10,500	T7	2,201
M2,5	11,400	T8	2,500
M 3	12,100	T9	3,000
M 3	13,100	T9	3,001
M3,5	14,250	T10	3,500
M 4	16,000	T15	4,000
M4,5	18,000	T15	4,500
M 5	19,750	T20	5,000
M 5	21,750	T20	5,001
M 5	23,400	T20	5,003
M 6	27,000	T25	6,000
M 6	28,500	T25	6,001
M 6	32,500	T25	6,002



HARTNER

Clés dynamométriques

N° d'article 86844



Entraînement		Couple Nm	L mm	Type	N° de code
1/4"	hexagonal	0,8-2	160,000	A	2,000
1/4"	hexagonal	2-8	200,000	A	8,000
1/4"	poignée transversale	5-14	200,000	E	14,000



HARTNER

Embouts pour vis Torx

N° d'article 86845



Entraînement		Torx	L mm	N° de code
1/4	hexagonal	T7	25,000	7,000
1/4	hexagonal	T8	25,000	8,000
1/4	hexagonal	T9	25,000	9,000
1/4	hexagonal	T10	25,000	10,000
1/4	hexagonal	T15	25,000	15,000
1/4	hexagonal	T20	25,000	20,000
1/4	hexagonal	T25	25,000	25,001



HARTNER

Tournevis Torx

N° d'article 86842



Tourne-vis Torx

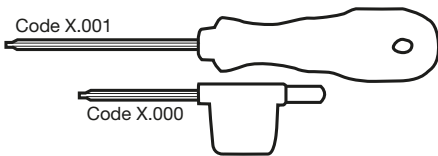

Torx	N° de code
T6	6,000
T6	6,001
T7	7,000
T7	7,001
T8	8,001
T9	9,001
T10	10,001
T15	15,000
T20	20,001
T25	25,001

CONSEILS D'UTILISATION



LES REVÊTEMENTS



○ Etat de surface poli

- ▼ Spécialement conçues pour la réalisation d'alliages d'aluminium et de fonte ainsi que d'alliages d'aluminium pour corroyage, les plaquettes interchangeables non revêtues fournissent de très bonnes performances d'usinage. Pour pallier l'usure par adhérence prédominante (formation d'arêtes rapportées), ces plaquettes interchangeables sont parfaitement adaptées à ce domaine d'application grâce à une géométrie spéciale associée à de grandes qualités de surface au niveau de l'amincissement de l'âme, de la goujure et de la dépouille.



● F Revêtement FIRE/nanoFIRE

- ▼ Caractéristiques visuelles : couleur noir voilé
- ▼ Revêtement TiAlN multi-couches avec structure graduelle. Revêtement complet avec une performance au moins 2 fois supérieure au TiN. Combine les avantages de TiN, TiAlN et TiCN. Isolant thermique excellent et « réfractaire ». Haute ténacité.



● a Revêtement AlTiN nano

- ▼ Caractéristiques visuelles : couleur noir violacé
- ▼ Notre revêtement éprouvé conçu à base de TiAlN a fait l'objet d'un développement permanent au sein de notre entreprise. Les propriétés mécaniques, chimiques et structurales optimales de la couche AlTiN entraînent une dureté à chaud très élevée, une très bonne résistance à l'oxydation ainsi qu'une excellente adhésion du revêtement. Il s'utilise uniquement avec du carbure pour l'usinage de matériaux très difficiles à usiner comme l'Inconel et les aciers trempés ainsi que pour les usinages difficiles (> 52 HRC) et l'usinage HSC. Convient extrêmement bien à l'usinage d'aciers inoxydables.



Y Revêtement TiAlSiN

- ▼ Caractéristiques visuelles : couleur rouge cuivré
- ▼ Revêtement multi-couches très dur et thermorésistant conçu spécialement pour l'usinage d'aciers trempés et d'aciers très résistants ainsi que de fonte. Grâce à sa structure en nanocomposites composée d'une structure stratifiée en TiAlN et SiN, la couche peut atteindre la dureté extrême de 5500HV.



T Revêtement TiN

- ▼ Caractéristiques visuelles : couleur jaune doré
- ▼ Revêtement polyvalent éprouvé et économique avec une dureté de 2200HV. Très bons résultats pour l'usinage général de l'acier.



A Revêtement TiAlN

- ▼ Caractéristiques visuelles : couleur noir violacé
- ▼ Revêtement spécial pour l'usinage de matériaux abrasifs (fonte, AISi) et/ou à charges thermiques élevées ainsi que pour des opérations sans refroidissement ou en cas de possibilité de refroidissement limitée, comme pour des perçages profonds ou de petits diamètres. Dans ce cas-ci, le revêtement entraîne des améliorations considérables uniquement lorsque les conditions de découpe sont élevées.

MULTIPLEX HPC – TECHNOLOGIE ET AVANTAGES

LORS DE L'UTILISATION DES OUTILS HARTNER MULTIPLEX HPC, VEUILLEZ SUIVRE LES INSTRUCTIONS ET RECOMMANDATIONS SUIVANTES :

Nous recommandons de remplacer également la vis de serrage à chaque changement de plaquette ! Chaque support est en effet fourni avec une vis de serrage, n° d'article 86843, et un tournevis, n° d'article 86842.

Chaque plaquette interchangeable est également fournie avec une vis de serrage, n° d'article 86843. Lors du changement de plaquette, veuillez respecter les couples de serrage suivants pour la vis de serrage. Le respect de ces recommandations est impératif pour obtenir des résultats d'usinage optimaux !

Diamètres	11,0 - 12,99	13,0 - 13,99	14,0 - 15,99	16,0 - 17,99	18,0 - 19,99	20,0 - 21,99	22,0 - 29,99	30,0 - 40,00
Filetages	M2,2	M2,5	M3	M3,5	M4	M4,5	M5	M6
Dimension Torx	T7	T8	T9	T10	T15	T15	T20	T25
Couple [Nm]	0,8	1,0	1,7	2,7	4,0	6,0	8,0	14,0

Ces indications sont valables pour le frein filet (Loctite) !

- ▼ Lors de perçages débouchants, s'assurer que les listels de guidage restent accessibles. Nous recommandons également de réduire l'avance avant de procéder au perçage traversant.
- ▼ Contrairement aux forets classiques à plaquettes interchangeables, Multiplex HPC convient également pour le perçage de paquets de tôles.
- ▼ Pour les tours (outil de perçage vertical), s'assurer que l'outil est placé exactement au centre.
- ▼ La condition d'un usinage optimal est une lubrification réfrigérante suffisante par émulsion ou par huile.

PILOTAGE / CHANFREINAGE

- ▼ Pour des profondeurs de perçage à partir de $5xD$, nous recommandons généralement de centrer ou piloter avec le support réf. 86681 et la plaquette de pilotage n° d'article 86721. Vous pouvez également utiliser un TS-Drill de type TS 100 U ou TS 100 INOX – selon le matériau à usiner.
- ▼ Pour un perçage sans centrage, nous recommandons de réduire l'avance à l'amorce du perçage.

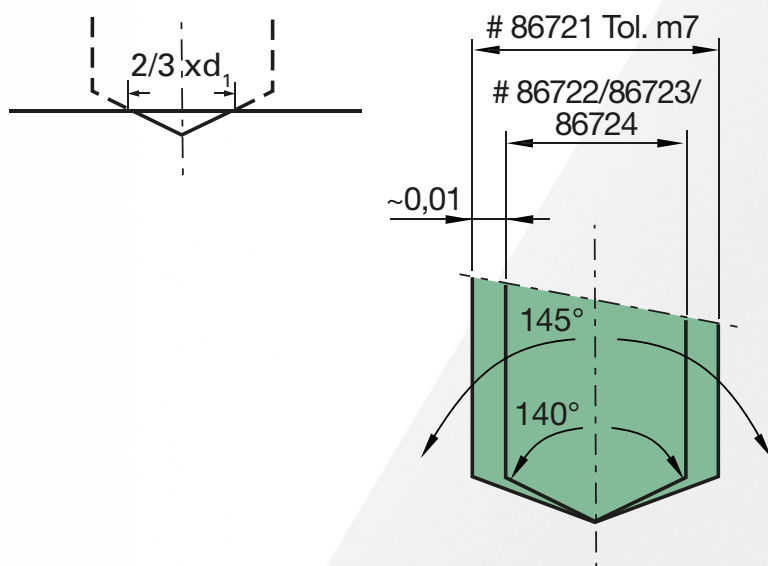

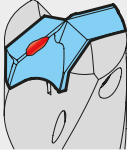
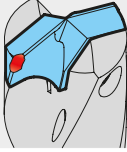
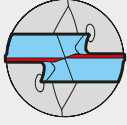
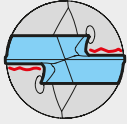
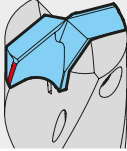
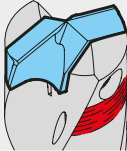

Incidents d'usinage

Erreur	Provenance	Remèdes
1 Collage 	<ul style="list-style-type: none"> ■ Vitesse de coupe trop faible ■ Affilage des arêtes de coupe trop important ■ Arêtes de coupe non revêtues 	<ul style="list-style-type: none"> ■ Augmenter la vitesse de coupe ■ Amoindrir la valeur de l'affilage ■ Revêtir la plaquette de coupe
2 Ebréchure des becs de la plaquette 	<ul style="list-style-type: none"> ■ Manque de rigidité de l'ensemble lors de l'usinage ■ Erreur de battement trop importante ■ Coupe interrompue 	<ul style="list-style-type: none"> ■ Améliorer le serrage de la pièce ■ Contrôler et éliminer l'erreur de battement ■ Réduire la valeur de l'avance
3 Usure anormale en dépouille 	<ul style="list-style-type: none"> ■ Vitesse de coupe trop élevée ■ Avance trop faible ■ Angle de la dépouille trop faible 	<ul style="list-style-type: none"> ■ Diminuer la vitesse de coupe ■ Augmenter l'avance ■ Augmenter la valeur de l'angle de la dépouille
4 Ebréchure des arêtes de coupe principales 	<ul style="list-style-type: none"> ■ Manque de rigidité de l'ensemble lors de l'usinage ■ Coupe interrompue ■ Valeur de l'usure maximale, dépassée ■ Type d'outil non approprié 	<ul style="list-style-type: none"> ■ Améliorer le serrage de la pièce ■ Réduire la valeur de l'avance ■ Echanger, plus souvent, la plaquette de coupe ■ Choisir un outil mieux approprié
5 Usure des listels périphériques 	<ul style="list-style-type: none"> ■ Manque de rigidité de l'ensemble lors de l'usinage ■ Erreur de battement trop importante ■ Conicité arrière insuffisante ■ Lubrifiant non approprié, concentration de l'huile soluble trop faible 	<ul style="list-style-type: none"> ■ Améliorer le serrage de la pièce ■ Contrôler et éliminer l'erreur de battement ■ Augmenter la conicité arrière ■ Utiliser une huile entière ou une huile soluble plus concentrée
6 Rayures sur le porte-outil 	<ul style="list-style-type: none"> ■ Manque de rigidité de l'ensemble lors de l'usinage ■ Erreur de battement trop importante ■ Coupe interrompue ■ Matériaux abrasifs 	<ul style="list-style-type: none"> ■ Améliorer le serrage de la pièce ■ Contrôler et éliminer l'erreur de battement ■ Réduire la valeur de l'avance ■ Utiliser une huile entière ou une huile soluble plus concentrée

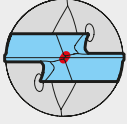
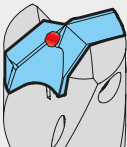
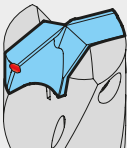
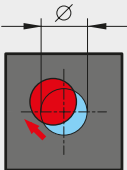
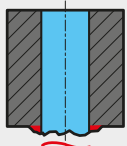
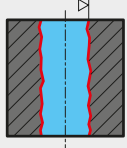

Incidents d'usinage

Erreur	Provenance	Remèdes
7 Usure anormale de l'arête transversale 	<ul style="list-style-type: none"> ■ Vitesse de coupe trop faible ■ Valeur de l'avance trop importante ■ Affilage des arêtes de coupe trop important 	<ul style="list-style-type: none"> ■ Augmenter la vitesse de coupe ■ Réduire la valeur de l'avance ■ Amoindrir la valeur de l'affilage
8 Ebréchure entre l'amincissement de l'âme et l'arête de coupe principale 	<ul style="list-style-type: none"> ■ Angle de la dépouille trop faible ■ Affilage des arêtes de coupe trop important ■ Type d'outil non approprié 	<ul style="list-style-type: none"> ■ Augmenter la valeur de l'angle de la dépouille ■ Amoindrir la valeur de l'affilage ■ Choisir un outil mieux approprié
9 Déformation plastique des becs 	<ul style="list-style-type: none"> ■ Vitesse de coupe trop élevée ■ Débit de lubrification trop faible ■ Renfort des becs mal réalisé, manque 	<ul style="list-style-type: none"> ■ Diminuer la vitesse de coupe ■ Augmenter les débit et pression du lubrifiant ■ Réaliser des renforts conformes au niveau des becs
10 Ecart d'alignement 	<ul style="list-style-type: none"> ■ Manque de rigidité de l'ensemble lors de l'usinage ■ Erreur de battement trop importante ■ Amorce de perçage sur plan incliné ■ Valeur du reste de l'arête transversale trop importante 	<ul style="list-style-type: none"> ■ Améliorer le serrage de la pièce ■ Contrôler et éliminer l'erreur de battement ■ Réaliser un perçage pilote avec une fraise 2 dents à 180° ■ Diminuer la valeur du reste de l'arête transversale
11 Bavure importante à la sortie du perçage 	<ul style="list-style-type: none"> ■ Valeur de l'avance trop importante ■ Valeur de l'usure maximale dépassée ■ Affilage des arêtes de coupe trop important 	<ul style="list-style-type: none"> ■ Réduire la valeur de l'avance ■ Echanger, plus souvent, la plaquette de coupe ■ Amoindrir la valeur de l'affilage
12 Mauvais état de surface 	<ul style="list-style-type: none"> ■ Manque de rigidité de l'ensemble lors de l'usinage ■ Erreur de battement trop importante ■ Débit de lubrification trop faible 	<ul style="list-style-type: none"> ■ Améliorer le serrage de la pièce ■ Contrôler et éliminer l'erreur de battement ■ Augmenter les débit et pression du lubrifiant



Conseils d'utilisation Multiplex HPC

N° d'article
Norme/DIN
Matière de coupe
Avec support
Profondeur
Version
Application
Prix/dim. page

Ø outil mm	Gamme d'avance n°								
	1	2	3	4	5	6	7	8	9
	f (mm/rotation)								
10,00	0,080	0,100	0,125	0,160	0,200	0,250	0,315	0,400	0,400
12,50	0,080	0,100	0,125	0,160	0,200	0,250	0,315	0,400	0,500
16,00	0,100	0,125	0,160	0,200	0,250	0,315	0,400	0,500	0,630
20,00	0,125	0,160	0,200	0,250	0,315	0,400	0,500	0,630	0,630
25,00	0,160	0,200	0,250	0,315	0,400	0,500	0,630	0,800	0,800
31,50	0,160	0,200	0,250	0,315	0,400	0,500	0,630	0,800	1,000
40,00	0,200	0,250	0,315	0,400	0,500	0,630	0,800	1,000	1,250

Produits de refroidissement:

- Air
- Huile
- Huile soluble

Les valeurs données le sont à titre indicatif. Les vitesses de coupe et avance effectivement atteintes dépendent de chaque condition réelle d'usinage. Nous vous conseillons les essais préalables correspondants.

Matières	Exemples, nouvelle désignation (Ancienne désignation entre parenthèses) Caractères gras = N° de matières suivant DIN EN	Résistance MPa (N/mm²)	Dureté	Prod. de réf.
Aciers de construction	1.0035 S185(St33), 1.0486 P275N(StE285), 1.0345 P235GH(H1), 1.0425 P265GH(H2)	≤500		○
	1.0050 E295 (St50-2), 1.0070 E360 (St70-2), 1.8937 P500NH (WStE500)	≤1000		○
Aciers de décolletage	1.0718 11SMnPb30 (9SMnPb28), 1.0736 11SMn37 (9SMn36)	≤850		○
	1.0727 46S20 (45S20), 1.0728 (60S20), 1.0757 46SPb20 (45SPb20)	≤1000		○
Aciers d'amélioration non-alliés	1.0402 C22, 1.1178 C30E (Ck30)	≤700		○
	1.0503 C45, 1.1191 C45E (Ck45)	≤850		○
	1.0601 C60, 1.1221 C60E (Ck60)	≤1000		○
Aciers d'amélioration alliés	1.5131 50MnSi4, 1.7003 38Cr2, 1.7030 28Cr4	≤1000		○
	1.5710 36NiCr6, 1.7035 41Cr4, 1.7225 42CrMo4	≤1400		○
Aciers de cémentation non-alliés	1.0301 (C10), 1.1121 C10E (Ck10)	≤850		○
Aciers de cémentation alliés	1.7276 10CrMo11, 1.5125 11MnSi6	≤1000		●
	1.5752 15NiCr13, 1.7131 16MnCr5, 1.7264 20CrMo5	≤1400		●
Aciers de nitruration	1.8504 34CrAl6	≤1000		○
	1.8519 31CrMoV9, 1.8550 34CrAlNi7	≤1400		●
Aciers à outils	1.1750 C75W, 1.2067 102Cr6, 1.2307 29CrMoV9	≤850		○
	1.2080 X210Cr12, 1.2083 X42Cr13, 1.2419 105WCr6, 1.2767 X45NiCrMo4	≤1400		●
Aciers rapides	1.3243 S 6-5-2-5, 1.3343 S 6-5-2, 1.3344 S 6-5-3	≤1400		●
Aciers à ressort	1.5026 55Si7, 1.7176 55Cr3, 1.8159 51CrV4 (51CrV4)		≤350 HB	●
Aciers trempés	-		≤48 HRC	●
			≤66 HRC	●
Aciers inoxydables, sulfurés	1.4005 X12CrS13, 1.4104 X14CrMoS17, 1.86681 X6CrMoS17, 1.4305 X8CrNiS18-9	≤900		●
austénitiques	1.4301 X5CrNi18-10 (V2A), 1.4541 X6CrNiTi18-10, 1.4571 X6CrNiMoTi 17-12-2 (V4A)	≤1100		●
martensitiques	1.4057 X20CrNi172 (X17CrNi16-2), 1.4122 X39CrMo17-1, 1.4521 X2CrMoTi18-2	≤1500		●
Fontes	0.6010 EN-GJL-100 (GG10), 0.6020 EN-GJL-200 (GG20)		≤240 HB	○
	0.6025 EN-GJL-250 (GG25), 0.6035 EN-GJL-350 (GG35)		≤350 HB	○
Fontes à graphite sphéroïdal et fontes malléables	0.7050 EN-GJS-500-7 (GGG50), 0.8035 EN-GJMw-350-4 (GTW35)		≤240 HB	○
	0.7070 EN-GJS-700-2 (GGG70), 0.8170 EN-GJMB-700-2 (GTS70)		≤350 HB	○
Fontes dures	-		≤350 HB	○
Nouvelles fontes GGV	EN-GJV250 (GGV25), EN-GJV350 (GGV35)		≤220 HB	○
	EN-GJV400 (GGV40), EN-GJV500 (GGV50), SiMo 6		≤300 HB	○
Nouvelles fontes ADI	EN-GJS-800-8 (ADI800), EN-GJS-1000-5 (ADI1000)	≤1000		○
	EN-GJS-1200-2 (ADI1200), EN-GJS-1400-1 (ADI1400)	≤1400		○
Alliages spéciaux	Nimonic, Inconel, Monel, Hastelloy	≤2000		●
Titane et alliages de Titane	3.7024 Ti99,5, 3.7114 TiAl5Sn2,5, 3.7124 TiCu2	≤850		●
	3.7154 TiAl6Zr5, 3.7165 TiAl6V4, 3.7184 TiAl4Mo4Sn2,5, - TiAl8Mo1V1	≤1400		●
Aluminium et ses alliages	3.0255 Al99,5, 3.2315 AlMgSi1, 3.3515 AlMg1	≤400		○
Alliages malléables d'Al	3.0615 AlMgSiPb, 3.1325 AlCuMg1, 3.3245 AlMg3Si, 3.4365 AlZnMgCu1,5	≤650		○
Alliages d'Al d'inject. ≤ 10 % Si	3.2131 G-AlSi5Cu1, 3.2153 G-AlSi7Cu3, 3.2573 G-AlSi9	≤600		○
≤ 24 % Si	3.2581 G-AlSi12, 3.2583 G-AlSi12Cu, - G-AlSi12CuNiMg	≤600		○
Alliages de Magnésium	3.5200 MgMn2, 3.5812.05 G-MgAl8Zn1, 3.5612.05 G-MgAl6Zn1	≤400		○
Cuivres, faiblement alliés	2.0070 SE-Cu, 2.1020 CuSn6, 2.1096 G-CuSn5ZnPb	≤500		○
Laiton à copeaux courts, à copeaux longs	2.0380 CuZn39Pb2, 2.0401 CuZn39Pb3, 2.0410 CuZn43Pb2	≤600		○
	2.0250 CuZn20, 2.0280 CuZn33, 2.0332 CuZn37Pb0,5	≤600		○
Bronze, à copeaux courts	2.1090 CuSn7ZnPb, 2.1170 CuPb5Sn5, 2.1176 CuPb10Sn	≤600		○
	2.0790 CuNi18Zn19Pb	≤850		○
Bronze, à copeaux longs	2.0916 CuAl5, 2.0960 CuAl9Mn, 2.1050 CuSn10	≤850		○
	2.0980 CuAl11Ni, 2.1247 CuBe2	≤1000		○
Thermodurcissables	Résine époxy, Resopal, Pertinax, Moltopren	≤150		○
Thermoplastiques	Plexiglas, Hostalen, Novodur, Makralon	≤100		○
renf. de fibres d'aramides	Kevlar	≤1000		○
renf. de fibres de verre ou carbone	GFK/CFK	≤1000		○



HARTNER

≤1xD/≤1,5xD

86722
WN
VHM
86681/86682
1,5xD
Aciers
20

86725
WN
VHM
86681/86682
1,5xD
Aciers inoxydables
24

86723
WN
VHM
86681/86682
1,5xD
Fonte
28

86724
WN
VHM
86681/86682
1,5xD
Alliage Al/Al
32

86721
WN
VHM
86681/86682
1xD/1,5xD
Pilotage/Chanfreinage
36

86729
WN
VHM
86681/86682
1,5xD
pour poutrelles en acier
40



v _c m/min	Gamme d'av. n°	v _c m/min	Gamme d'av. n°	v _c m/min	Gamme d'av. n°	v _c m/min	Gamme d'av. n°	v _c m/min	Gamme d'av. n°	v _c m/min	Gamme d'av. n°
130	6							130	6	100	5
110	5							110	5	80	5
130	7							130	7		
110	6							110	6		
130	6							130	6		
125	6							125	6		
110	5							110	5		
110	6							110	6		
90	5							90	5		
130	7							130	7		
110	6							110	6		
70	4							70	4		
105	5							105	5		
70	4							70	4		
60	5							60	5		
55	4							55	4		
55	3							55	3		
50	2							50	2		
		25	2					25	2		
		55	3					55	3		
		40	3					40	3		
		35	3					35	3		
				100	6			100	6		
				90	6			90	6		
				120	7			120	7		
				100	6			100	6		
		90	6					90	6		
				80	5			80	5		
				80	5			80	5		
				80	5			80	5		
				80	5			80	5		
		25	2					25	2		
		40	3					40	3		
		35	2					35	2		
						200	7	200	7		
						180	7	180	7		
						150	7	150	7		
						120	7	120	7		
						180	7	180	7		
						70	6	70	6		
						180	7	180	7		
						120	6	120	6		
						70	6	70	6		
						50	6	50	6		
						45	6	45	6		
						35	5	35	5		



Conseils d'utilisation Multiplex HPC

N° d'article
Norme/DIN
Matière de coupe
Avec support
Profondeur
Version
Application
Prix/dim. page

Ø outil mm	Gamme d'avance n°								
	1	2	3	4	5	6	7	8	9
	f (mm/rotation)								
10,00	0,080	0,100	0,125	0,160	0,200	0,250	0,315	0,400	0,400
12,50	0,080	0,100	0,125	0,160	0,200	0,250	0,315	0,400	0,500
16,00	0,100	0,125	0,160	0,200	0,250	0,315	0,400	0,500	0,630
20,00	0,125	0,160	0,200	0,250	0,315	0,400	0,500	0,630	0,630
25,00	0,160	0,200	0,250	0,315	0,400	0,500	0,630	0,800	0,800
31,50	0,160	0,200	0,250	0,315	0,400	0,500	0,630	0,800	1,000
40,00	0,200	0,250	0,315	0,400	0,500	0,630	0,800	1,000	1,250

Produits de refroidissement:

- Air
- Huile
- Huile soluble

Les valeurs données le sont à titre indicatif. Les vitesses de coupe et avance effectivement atteintes dépendent de chaque condition réelle d'usinage. Nous vous conseillons les essais préalables correspondants.

Matières	Exemples, nouvelle désignation (Ancienne désignation entre parenthèses) Caractères gras = N° de matières suivant DIN EN	Résistance MPa (N/mm²)	Dureté	Prod. de réf.
Aciers de construction	1.0035 S185(St33), 1.0486 P275N(StE285), 1.0345 P235GH(H1), 1.0425 P265GH(H2) 1.0050 E295 (St50-2), 1.0070 E360 (St70-2), 1.8937 P500NH (WStE500)	≤500 ≤1000		○ ○
Aciers de décolletage	1.0718 11SMnPb30 (9SMnPb28), 1.0736 11SMn37 (9SMn36) 1.0727 46S20 (45S20), 1.0728 (60S20), 1.0757 46SPb20 (45SPb20)	≤850 ≤1000		○ ○
Aciers d'amélioration non-alliés	1.0402 C22, 1.1178 C30E (Ck30) 1.0503 C45, 1.1191 C45E (Ck45) 1.0601 C60, 1.1221 C60E (Ck60)	≤700 ≤850 ≤1000		○ ○ ○
Aciers d'amélioration alliés	1.5131 50MnSi4, 1.7003 38Cr2, 1.7030 28Cr4 1.5710 36NiCr6, 1.7035 41Cr4, 1.7225 42CrMo4	≤1000 ≤1400		○ ○
Aciers de cémentation non-alliés	1.0301 (C10), 1.1121 C10E (Ck10)	≤850		○
Aciers de cémentation alliés	1.7276 10CrMo11, 1.5125 11MnSi6 1.5752 15NiCr13, 1.7131 16MnCr5, 1.7264 20CrMo5	≤1000 ≤1400		● ●
Aciers de nitruration	1.8504 34CrAl6 1.8519 31CrMoV9, 1.8550 34CrAlNi7	≤1000 ≤1400		○ ●
Aciers à outils	1.1750 C75W, 1.2067 102Cr6, 1.2307 29CrMoV9 1.2080 X210Cr12, 1.2083 X42Cr13, 1.2419 105WCr6, 1.2767 X45NiCrMo4	≤850 ≤1400		○ ●
Aciers rapides	1.3243 S 6-5-2-5, 1.3343 S 6-5-2, 1.3344 S 6-5-3	≤1400		●
Aciers à ressort	1.5026 55Si7, 1.7176 55Cr3, 1.8159 51CrV4 (51CrV4)		≤350 HB	●
Aciers trempés	-		≤48 HRC ≤66 HRC	● ●
Aciers inoxydables, sulfurés austénitiques martensitiques	1.4005 X12CrS13, 1.4104 X14CrMoS17, 1.86681 X6CrMoS17, 1.4305 X8CrNiS18-9 1.4301 X5CrNi18-10 (V2A), 1.4541 X6CrNiTi18-10, 1.4571 X6CrNiMoTi 17-12-2 (V4A) 1.4057 X20CrNi172 (X17CrNi16-2), 1.4122 X39CrMo17-1, 1.4521 X2CrMoTi18-2	≤900 ≤1100 ≤1500		● ● ●
Fontes	0.6010 EN-GJL-100 (GG10), 0.6020 EN-GJL-200 (GG20) 0.6025 EN-GJL-250 (GG25), 0.6035 EN-GJL-350 (GG35)		≤240 HB ≤350 HB	○ ○
Fontes à graphite sphéroïdal et fontes malléables	0.7050 EN-GJS-500-7 (GGG50), 0.8035 EN-GJMw-350-4 (GTW35) 0.7070 EN-GJS-700-2 (GGG70), 0.8170 EN-GJMB-700-2 (GTS70)		≤240 HB ≤350 HB	○ ○
Fontes dures	-		≤350 HB	○
Nouvelles fontes GGV	EN-GJV250 (GGV25), EN-GJV350 (GGV35) EN-GJV400 (GGV40), EN-GJV500 (GGV50), SiMo 6		≤220 HB ≤300 HB	○ ○
Nouvelles fontes ADI	EN-GJS-800-8 (ADI800), EN-GJS-1000-5 (ADI1000) EN-GJS-1200-2 (ADI1200), EN-GJS-1400-1 (ADI1400)	≤1000 ≤1400		○ ○
Alliages spéciaux	Nimonic, Inconel, Monel, Hastelloy	≤2000		●
Titane et alliages de Titane	3.7024 Ti99,5, 3.7114 TiAl5Sn2,5, 3.7124 TiCu2 3.7154 TiAl6Zr5, 3.7165 TiAl6V4, 3.7184 TiAl4Mo4Sn2,5, - TiAl8Mo1V1	≤850 ≤1400		● ●
Aluminium et ses alliages	3.0255 Al99,5, 3.2315 AlMgSi1, 3.3515 AlMg1	≤400		○
Alliages malléables d'Al	3.0615 AlMgSiPb, 3.1325 AlCuMg1, 3.3245 AlMg3Si, 3.4365 AlZnMgCu1,5	≤650		○
Alliages d'Al d'inject. ≤ 10 % Si ≤ 24 % Si	3.2131 G-AlSi5Cu1, 3.2153 G-AlSi7Cu3, 3.2573 G-AlSi9 3.2581 G-AlSi12, 3.2583 G-AlSi12Cu, - G-AlSi12CuNiMg	≤600 ≤600		○ ○
Alliages de Magnésium	3.5200 MgMn2, 3.5812.05 G-MgAl8Zn1, 3.5612.05 G-MgAl6Zn1	≤400		○
Cuivres, faiblement alliés	2.0070 SE-Cu, 2.1020 CuSn6, 2.1096 G-CuSn5ZnPb	≤500		○
Laiton à copeaux courts, à copeaux longs	2.0380 CuZn39Pb2, 2.0401 CuZn39Pb3, 2.0410 CuZn43Pb2 2.0250 CuZn20, 2.0280 CuZn33, 2.0332 CuZn37Pb0,5	≤600 ≤600		○ ○
Bronze, à copeaux courts	2.1090 CuSn7ZnPb, 2.1170 CuPb5Sn5, 2.1176 CuPb10Sn 2.0790 CuNi18Zn19Pb	≤600 ≤850		○ ●
Bronze, à copeaux longs	2.0916 CuAl5, 2.0960 CuAl9Mn, 2.1050 CuSn10 2.0980 CuAl1Ni, 2.1247 CuBe2	≤850 ≤1000		● ●
Thermodurcissables	Résine époxy, Resopal, Pertinax, Moltopren	≤150		○
Thermoplastiques renf. de fibres d'aramides renf. de fibres de verre ou carbone	Plexiglas, Hostalen, Novodur, Makralon Kevlar GFK/CFK	≤100 ≤1000 ≤1000		○ ○ ○

≤3xD

86722
WN
VHM
86683
3xD

Aciers
20

86725
WN
VHM
86683
3xD

Aciers inoxydables
24

86723
WN
VHM
86683
3xD

Fonte
28

86724
WN
VHM
86683
3xD

Alliage Al/Al
32

86729
WN
VHM
86683
3xD

pour poutrelles en acier
40



v_c m/min	Gamme d'av. n°	v_c m/min	Gamme d'av. n°	v_c m/min	Gamme d'av. n°	v_c m/min	Gamme d'av. n°	v_c m/min	Gamme d'av. n°
130	6							90	5
110	5							75	5
130	7								
110	6								
130	6								
125	6								
110	5								
110	6								
90	5								
130	7								
110	6								
70	4								
105	5								
70	4								
60	5								
55	4								
55	3								
50	2								
		25	2						
		55	3						
		40	3						
		35	3						
				100	6				
				90	6				
				120	7				
				100	6				
		90	6						
				80	5				
				80	5				
				80	5				
				80	5				
		25	2					200	7
		40	3					180	7
		35	2					150	7
								120	7
								180	7
								70	6
								180	7
								120	6
								70	6
								50	6
								45	6
								35	5



Conseils d'utilisation Multiplex HPC

N° d'article
Norme/DIN
Matière de coupe
Avec support
Profondeur
Version
Application
Prix/dim. page

Ø outil mm	Gamme d'avance n°								
	1	2	3	4	5	6	7	8	9
	f (mm/rotation)								
10,00	0,080	0,100	0,125	0,160	0,200	0,250	0,315	0,400	0,400
12,50	0,080	0,100	0,125	0,160	0,200	0,250	0,315	0,400	0,500
16,00	0,100	0,125	0,160	0,200	0,250	0,315	0,400	0,500	0,630
20,00	0,125	0,160	0,200	0,250	0,315	0,400	0,500	0,630	0,630
25,00	0,160	0,200	0,250	0,315	0,400	0,500	0,630	0,800	0,800
31,50	0,160	0,200	0,250	0,315	0,400	0,500	0,630	0,800	1,000
40,00	0,200	0,250	0,315	0,400	0,500	0,630	0,800	1,000	1,250

Produits de refroidissement:

- Air
- Huile
- Huile soluble

Les valeurs données le sont à titre indicatif. Les vitesses de coupe et avance effectivement atteintes dépendent de chaque condition réelle d'usinage.

Nous vous conseillons les essais préalables correspondants.

Matières	Exemples, nouvelle désignation (Ancienne désignation entre parenthèses) Caractères gras = N° de matières suivant DIN EN	Résistance MPa (N/mm²)	Dureté	Prod. de réf.
Aciers de construction	1.0035 S185(St33), 1.0486 P275N(StE285), 1.0345 P235GH(H1), 1.0425 P265GH(H2)	≤500		○
	1.0050 E295 (St50-2), 1.0070 E360 (St70-2), 1.8937 P500NH (WStE500)	≤1000		○
Aciers de décolletage	1.0718 11SMnPb30 (9SMnPb28), 1.0736 11SMn37 (9SMn36)	≤850		○
	1.0727 46S20 (45S20), 1.0728 (60S20), 1.0757 46SPb20 (45SPb20)	≤1000		○
Aciers d'amélioration non-alliés	1.0402 C22, 1.1178 C30E (Ck30)	≤700		○
	1.0503 C45, 1.1191 C45E (Ck45)	≤850		○
	1.0601 C60, 1.1221 C60E (Ck60)	≤1000		○
Aciers d'amélioration alliés	1.5131 50MnSi4, 1.7003 38Cr2, 1.7030 28Cr4	≤1000		○
	1.5710 36NiCr6, 1.7035 41Cr4, 1.7225 42CrMo4	≤1400		○
Aciers de cémentation non-alliés	1.0301 (C10), 1.1121 C10E (Ck10)	≤850		○
Aciers de cémentation alliés	1.7276 10CrMo11, 1.5125 11MnSi6	≤1000		●
	1.5752 15NiCr13, 1.7131 16MnCr5, 1.7264 20CrMo5	≤1400		●
Aciers de nitruration	1.8504 34CrAl6	≤1000		○
	1.8519 31CrMoV9, 1.8550 34CrAlNi7	≤1400		●
Aciers à outils	1.1750 C75W, 1.2067 102Cr6, 1.2307 29CrMoV9	≤850		○
	1.2080 X210Cr12, 1.2083 X42Cr13, 1.2419 105WCr6, 1.2767 X45NiCrMo4	≤1400		●
Aciers rapides	1.3243 S 6-5-2-5, 1.3343 S 6-5-2, 1.3344 S 6-5-3	≤1400		●
Aciers à ressort	1.5026 55Si7, 1.7176 55Cr3, 1.8159 51CrV4 (51CrV4)		≤350 HB	●
Aciers trempés	-		≤48 HRC	●
			≤66 HRC	●
Aciers inoxydables, sulfurés	1.4005 X12CrS13, 1.4104 X14CrMoS17, 1.86681 X6CrMoS17, 1.4305 X8CrNiS18-9	≤900		●
austénitiques	1.4301 X5CrNi18-10 (V2A), 1.4541 X6CrNiTi18-10, 1.4571 X6CrNiMoTi 17-12-2 (V4A)	≤1100		●
martensitiques	1.4057 X20CrNi172 (X17CrNi16-2), 1.4122 X39CrMo17-1, 1.4521 X2CrMoTi18-2	≤1500		●
Fontes	0.6010 EN-GJL-100 (GG10), 0.6020 EN-GJL-200 (GG20)		≤240 HB	○
	0.6025 EN-GJL-250 (GG25), 0.6035 EN-GJL-350 (GG35)		≤350 HB	○
Fontes à graphite sphéroïdal et fontes malléables	0.7050 EN-GJS-500-7 (GGG50), 0.8035 EN-GJMw-350-4 (GTW35)		≤240 HB	○
	0.7070 EN-GJS-700-2 (GGG70), 0.8170 EN-GJMB-700-2 (GTS70)		≤350 HB	○
Fontes dures	-		≤350 HB	○
Nouvelles fontes GGV	EN-GJV250 (GGV25), EN-GJV350 (GGV35)		≤220 HB	○
	EN-GJV400 (GGV40), EN-GJV500 (GGV50), SiMo 6		≤300 HB	○
Nouvelles fontes ADI	EN-GJS-800-8 (ADI800), EN-GJS-1000-5 (ADI1000)	≤1000		○
	EN-GJS-1200-2 (ADI1200), EN-GJS-1400-1 (ADI1400)	≤1400		○
Alliages spéciaux	Nimonic, Inconel, Monel, Hastelloy	≤2000		●
Titane et alliages de Titane	3.7024 Ti99,5, 3.7114 TiAl5Sn2,5, 3.7124 TiCu2	≤850		●
	3.7154 TiAl6Zr5, 3.7165 TiAl6V4, 3.7184 TiAl4Mo4Sn2,5, - TiAl8Mo1V1	≤1400		●
Aluminium et ses alliages	3.0255 Al99,5, 3.2315 AlMgSi1, 3.3515 AlMg1	≤400		○
Alliages malléables d'Al	3.0615 AlMgSiPb, 3.1325 AlCuMg1, 3.3245 AlMg3Si, 3.4365 AlZnMgCu1,5	≤650		○
Alliages d'Al d'inject. ≤ 10 % Si	3.2131 G-AlSi5Cu1, 3.2153 G-AlSi7Cu3, 3.2573 G-AlSi9	≤600		○
≤ 24 % Si	3.2581 G-AlSi12, 3.2583 G-AlSi12Cu, - G-AlSi12CuNiMg	≤600		○
Alliages de Magnésium	3.5200 MgMn2, 3.5812.05 G-MgAl8Zn1, 3.5612.05 G-MgAl6Zn1	≤400		○
Cuivres, faiblement alliés	2.0070 SE-Cu, 2.1020 CuSn6, 2.1096 G-CuSn5ZnPb	≤500		○
Laiton à copeaux courts, à copeaux longs	2.0380 CuZn39Pb2, 2.0401 CuZn39Pb3, 2.0410 CuZn43Pb2	≤600		○
	2.0250 CuZn20, 2.0280 CuZn33, 2.0332 CuZn37Pb0,5	≤600		○
Bronze, à copeaux courts	2.1090 CuSn7ZnPb, 2.1170 CuPb5Sn5, 2.1176 CuPb10Sn	≤600		○
	2.0790 CuNi18Zn19Pb	≤850		○
Bronze, à copeaux longs	2.0916 CuAl5, 2.0960 CuAl9Mn, 2.1050 CuSn10	≤850		○
	2.0980 CuAl11Ni, 2.1247 CuBe2	≤1000		○
Thermodurcissables	Résine époxy, Resopal, Pertinax, Moltopren	≤150		○
Thermoplastiques	Plexiglas, Hostalen, Novodur, Makralon	≤100		○
renf. de fibres d'aramides	Kevlar	≤1000		○
renf. de fibres de verre ou carbone	GFK/CFK	≤1000		○



≤5xD

86722
WN
VHM
86684
5xD
F
Aciers
20

86725
WN
VHM
86684
5xD
a
Aciers inoxydables
24

86723
WN
VHM
86684
5xD
Y
Fonte
28

86724
WN
VHM
86684
5xD
○
Alliage Al/Al
32

86729
WN
VHM
86684
5xD
F
pour poutrelles en acier
40



v_c m/min	Gamme d'av. n°	v_c m/min	Gamme d'av. n°	v_c m/min	Gamme d'av. n°	v_c m/min	Gamme d'av. n°	v_c m/min	Gamme d'av. n°
125	6							90	5
105	5							75	5
125	7								
105	6								
125	6								
120	6								
105	5								
105	6								
85	5								
125	7								
105	6								
70	4								
105	5								
70	4								
55	5								
50	4								
55	3								
50	2								
		25	2						
		55	3						
		40	3						
		35	3						
				100	6				
				90	6				
				120	7				
				100	6				
		90	6						
				80	5				
				80	5				
				80	5				
				80	5				
		25	2						
		40	3						
		35	2						
						180	7		
						180	7		
						140	7		
						110	7		
						180	7		
						70	6		
						180	7		
						120	6		
						70	6		
						50	6		
						45	6		
						35	5		



Conseils d'utilisation Multiplex HPC

N° d'article
Norme/DIN
Matière de coupe
Avec support
Profondeur
Version
Application
Prix/dim. page

Ø outil mm	Gamme d'avance n°								
	1	2	3	4	5	6	7	8	9
	f (mm/rotation)								
10,00	0,080	0,100	0,125	0,160	0,200	0,250	0,315	0,400	0,400
12,50	0,080	0,100	0,125	0,160	0,200	0,250	0,315	0,400	0,500
16,00	0,100	0,125	0,160	0,200	0,250	0,315	0,400	0,500	0,630
20,00	0,125	0,160	0,200	0,250	0,315	0,400	0,500	0,630	0,630
25,00	0,160	0,200	0,250	0,315	0,400	0,500	0,630	0,800	0,800
31,50	0,160	0,200	0,250	0,315	0,400	0,500	0,630	0,800	1,000
40,00	0,200	0,250	0,315	0,400	0,500	0,630	0,800	1,000	1,250

Produits de refroidissement:

- Air
- Huile
- Huile soluble

Les valeurs données le sont à titre indicatif. Les vitesses de coupe et avance effectivement atteintes dépendent de chaque condition réelle d'usinage. Nous vous conseillons les essais préalables correspondants.

Matières	Exemples, nouvelle désignation (Ancienne désignation entre parenthèses) Caractères gras = N° de matières suivant DIN EN	Résistance MPa (N/mm²)	Dureté	Prod. de réf.
Aciers de construction	1.0035 S185(St33), 1.0486 P275N(StE285), 1.0345 P235GH(H1), 1.0425 P265GH(H2)	≤500		○
	1.0050 E295 (St50-2), 1.0070 E360 (St70-2), 1.8937 P500NH (WStE500)	≤1000		○
Aciers de décolletage	1.0718 11SMnPb30 (9SMnPb28), 1.0736 11SMn37 (9SMn36)	≤850		○
	1.0727 46S20 (45S20), 1.0728 (60S20), 1.0757 46SPb20 (45SPb20)	≤1000		○
Aciers d'amélioration non-alliés	1.0402 C22, 1.1178 C30E (Ck30)	≤700		○
	1.0503 C45, 1.1191 C45E (Ck45)	≤850		○
	1.0601 C60, 1.1221 C60E (Ck60)	≤1000		○
Aciers d'amélioration alliés	1.5131 50MnSi4, 1.7003 38Cr2, 1.7030 28Cr4	≤1000		○
	1.5710 36NiCr6, 1.7035 41Cr4, 1.7225 42CrMo4	≤1400		○
Aciers de cémentation non-alliés	1.0301 (C10), 1.1121 C10E (Ck10)	≤850		○
Aciers de cémentation alliés	1.7276 10CrMo11, 1.5125 11MnSi6	≤1000		●
	1.5752 15NiCr13, 1.7131 16MnCr5, 1.7264 20CrMo5	≤1400		●
Aciers de nitruration	1.8504 34CrAl6	≤1000		○
	1.8519 31CrMoV9, 1.8550 34CrAlNi7	≤1400		●
Aciers à outils	1.1750 C75W, 1.2067 102Cr6, 1.2307 29CrMoV9	≤850		○
	1.2080 X210Cr12, 1.2083 X42Cr13, 1.2419 105WCr6, 1.2767 X45NiCrMo4	≤1400		●
Aciers rapides	1.3243 S 6-5-2-5, 1.3343 S 6-5-2, 1.3344 S 6-5-3	≤1400		●
Aciers à ressort	1.5026 55Si7, 1.7176 55Cr3, 1.8159 51CrV4 (51CrV4)		≤350 HB	●
Aciers trempés	-		≤48 HRC	●
			≤66 HRC	●
Aciers inoxydables, sulfurés	1.4005 X12CrS13, 1.4104 X14CrMoS17, 1.86681 X6CrMoS17, 1.4305 X8CrNiS18-9	≤900		●
austénitiques	1.4301 X5CrNi18-10 (V2A), 1.4541 X6CrNiTi18-10, 1.4571 X6CrNiMoTi 17-12-2 (V4A)	≤1100		●
martensitiques	1.4057 X20CrNi172 (X17CrNi16-2), 1.4122 X39CrMo17-1, 1.4521 X2CrMoTi18-2	≤1500		●
Fontes	0.6010 EN-GJL-100 (GG10), 0.6020 EN-GJL-200 (GG20)		≤240 HB	○
	0.6025 EN-GJL-250 (GG25), 0.6035 EN-GJL-350 (GG35)		≤350 HB	○
Fontes à graphite sphéroïdal et fontes malléables	0.7050 EN-GJS-500-7 (GGG50), 0.8035 EN-GJMW-350-4 (GTW35)		≤240 HB	○
	0.7070 EN-GJS-700-2 (GGG70), 0.8170 EN-GJMB-700-2 (GTS70)		≤350 HB	○
Fontes dures	-		≤350 HB	○
Nouvelles fontes GGV	EN-GJV250 (GGV25), EN-GJV350 (GGV35)		≤220 HB	○
	EN-GJV400 (GGV40), EN-GJV500 (GGV50), SiMo 6		≤300 HB	○
Nouvelles fontes ADI	EN-GJS-800-8 (ADI800), EN-GJS-1000-5 (ADI1000)	≤1000		○
	EN-GJS-1200-2 (ADI1200), EN-GJS-1400-1 (ADI1400)	≤1400		○
Alliages spéciaux	Nimonic, Inconel, Monel, Hastelloy	≤2000		●
Titane et alliages de Titane	3.7024 Ti99,5, 3.7114 TiAl5Sn2,5, 3.7124 TiCu2	≤850		●
	3.7154 TiAl6Zr5, 3.7165 TiAl6V4, 3.7184 TiAl4Mo4Sn2,5, - TiAl8Mo1V1	≤1400		●
Aluminium et ses alliages	3.0255 Al99,5, 3.2315 AlMgSi1, 3.3515 AlMg1	≤400		○
Alliages malléables d'Al	3.0615 AlMgSiPb, 3.1325 AlCuMg1, 3.3245 AlMg3Si, 3.4365 AlZnMgCu1,5	≤650		○
Alliages d'Al d'inject. ≤ 10 % Si	3.2131 G-AlSi5Cu1, 3.2153 G-AlSi7Cu3, 3.2573 G-AlSi9	≤600		○
≤ 24 % Si	3.2581 G-AlSi12, 3.2583 G-AlSi12Cu, - G-AlSi12CuNiMg	≤600		○
Alliages de Magnésium	3.5200 MgMn2, 3.5812.05 G-MgAl8Zn1, 3.5612.05 G-MgAl6Zn1	≤400		○
Cuivres, faiblement alliés	2.0070 SE-Cu, 2.1020 CuSn6, 2.1096 G-CuSn5ZnPb	≤500		○
Laiton à copeaux courts, à copeaux longs	2.0380 CuZn39Pb2, 2.0401 CuZn39Pb3, 2.0410 CuZn43Pb2	≤600		○
	2.0250 CuZn20, 2.0280 CuZn33, 2.0332 CuZn37Pb0,5	≤600		○
Bronze, à copeaux courts	2.1090 CuSn7ZnPb, 2.1170 CuPb5Sn5, 2.1176 CuPb10Sn	≤600		○
	2.0790 CuNi18Zn19Pb	≤850		○
Bronze, à copeaux longs	2.0916 CuAl5, 2.0960 CuAl9Mn, 2.1050 CuSn10	≤850		○
	2.0980 CuAl11Ni, 2.1247 CuBe2	≤1000		○
Thermodurcissables	Résine époxy, Resopal, Pertinax, Moltopren	≤150		○
Thermoplastiques	Plexiglas, Hostalen, Novodur, Makralon	≤100		○
renf. de fibres d'aramides	Kevlar	≤1000		○
renf. de fibres de verre ou carbone	GFK/CFK	≤1000		○



Conseils d'utilisation Multiplex HPC

N° d'article
Norme/DIN
Matière de coupe
Avec support
Profondeur
Version
Application
Prix/dim. page

Ø outil mm	Gamme d'avance n°								
	1	2	3	4	5	6	7	8	9
	f (mm/rotation)								
10,00	0,080	0,100	0,125	0,160	0,200	0,250	0,315	0,400	0,400
12,50	0,080	0,100	0,125	0,160	0,200	0,250	0,315	0,400	0,500
16,00	0,100	0,125	0,160	0,200	0,250	0,315	0,400	0,500	0,630
20,00	0,125	0,160	0,200	0,250	0,315	0,400	0,500	0,630	0,630
25,00	0,160	0,200	0,250	0,315	0,400	0,500	0,630	0,800	0,800
31,50	0,160	0,200	0,250	0,315	0,400	0,500	0,630	0,800	1,000
40,00	0,200	0,250	0,315	0,400	0,500	0,630	0,800	1,000	1,250

Produits de refroidissement:

- Air
- Huile
- Huile soluble

Les valeurs données le sont à titre indicatif. Les vitesses de coupe et avance effectivement atteintes dépendent de chaque condition réelle d'usinage. Nous vous conseillons les essais préalables correspondants.

Matières	Exemples, nouvelle désignation (Ancienne désignation entre parenthèses) Caractères gras = N° de matières suivant DIN EN	Résistance MPa (N/mm²)	Dureté	Prod. de réf.
Aciers de construction	1.0035 S185(St33), 1.0486 P275N(StE285), 1.0345 P235GH(H1), 1.0425 P265GH(H2)	≤500		○
	1.0050 E295 (St50-2), 1.0070 E360 (St70-2), 1.8937 P500NH (WStE500)	≤1000		○
Aciers de décolletage	1.0718 11SMnPb30 (9SMnPb28), 1.0736 11SMn37 (9SMn36)	≤850		○
	1.0727 46S20 (45S20), 1.0728 (60S20), 1.0757 46SPb20 (45SPb20)	≤1000		○
Aciers d'amélioration non-alliés	1.0402 C22, 1.1178 C30E (Ck30)	≤700		○
	1.0503 C45, 1.1191 C45E (Ck45)	≤850		○
	1.0601 C60, 1.1221 C60E (Ck60)	≤1000		○
Aciers d'amélioration alliés	1.5131 50MnSi4, 1.7003 38Cr2, 1.7030 28Cr4	≤1000		○
	1.5710 36NiCr6, 1.7035 41Cr4, 1.7225 42CrMo4	≤1400		○
Aciers de cémentation non-alliés	1.0301 (C10), 1.1121 C10E (Ck10)	≤850		○
Aciers de cémentation alliés	1.7276 10CrMo11, 1.5125 11MnSi6	≤1000		●
	1.5752 15NiCr13, 1.7131 16MnCr5, 1.7264 20CrMo5	≤1400		●
Aciers de nitruration	1.8504 34CrAl6	≤1000		○
	1.8519 31CrMoV9, 1.8550 34CrAlNi7	≤1400		●
Aciers à outils	1.1750 C75W, 1.2067 102Cr6, 1.2307 29CrMoV9	≤850		○
	1.2080 X210Cr12, 1.2083 X42Cr13, 1.2419 105WCr6, 1.2767 X45NiCrMo4	≤1400		●
Aciers rapides	1.3243 S 6-5-2-5, 1.3343 S 6-5-2, 1.3344 S 6-5-3	≤1400		●
Aciers à ressort	1.5026 55Si7, 1.7176 55Cr3, 1.8159 51CrV4 (51CrV4)		≤350 HB	●
Aciers trempés	-		≤48 HRC	●
			≤66 HRC	●
Aciers inoxydables, sulfurés	1.4005 X12CrS13, 1.4104 X14CrMoS17, 1.86681 X6CrMoS17, 1.4305 X8CrNiS18-9	≤900		●
austénitiques	1.4301 X5CrNi18-10 (V2A), 1.4541 X6CrNiTi18-10, 1.4571 X6CrNiMoTi 17-12-2 (V4A)	≤1100		●
martensitiques	1.4057 X20CrNi172 (X17CrNi16-2), 1.4122 X39CrMo17-1, 1.4521 X2CrMoTi18-2	≤1500		●
Fontes	0.6010 EN-GJL-100 (GG10), 0.6020 EN-GJL-200 (GG20)		≤240 HB	○
	0.6025 EN-GJL-250 (GG25), 0.6035 EN-GJL-350 (GG35)		≤350 HB	○
Fontes à graphite sphéroïdal et fontes malléables	0.7050 EN-GJS-500-7 (GGG50), 0.8035 EN-GJMW-350-4 (GTW35)		≤240 HB	○
	0.7070 EN-GJS-700-2 (GGG70), 0.8170 EN-GJMB-700-2 (GTS70)		≤350 HB	○
Fontes dures	-		≤350 HB	○
Nouvelles fontes GGV	EN-GJV250 (GGV25), EN-GJV350 (GGV35)		≤220 HB	○
	EN-GJV400 (GGV40), EN-GJV500 (GGV50), SiMo 6		≤300 HB	○
Nouvelles fontes ADI	EN-GJS-800-8 (ADI800), EN-GJS-1000-5 (ADI1000)	≤1000		○
	EN-GJS-1200-2 (ADI1200), EN-GJS-1400-1 (ADI1400)	≤1400		○
Alliages spéciaux	Nimonic, Inconel, Monel, Hastelloy	≤2000		●
Titane et alliages de Titane	3.7024 Ti99,5, 3.7114 TiAl5Sn2,5, 3.7124 TiCu2	≤850		●
	3.7154 TiAl6Zr5, 3.7165 TiAl6V4, 3.7184 TiAl4Mo4Sn2,5, - TiAl8Mo1V1	≤1400		●
Aluminium et ses alliages	3.0255 Al99,5, 3.2315 AlMgSi1, 3.3515 AlMg1	≤400		○
Alliages malléables d'Al	3.0615 AlMgSiPb, 3.1325 AlCuMg1, 3.3245 AlMg3Si, 3.4365 AlZnMgCu1,5	≤650		○
Alliages d'Al d'inject. ≤ 10 % Si	3.2131 G-AlSi5Cu1, 3.2153 G-AlSi7Cu3, 3.2573 G-AlSi9	≤600		○
≤ 24 % Si	3.2581 G-AlSi12, 3.2583 G-AlSi12Cu, - G-AlSi12CuNiMg	≤600		○
Alliages de Magnésium	3.5200 MgMn2, 3.5812.05 G-MgAl8Zn1, 3.5612.05 G-MgAl6Zn1	≤400		○
Cuivres, faiblement alliés	2.0070 SE-Cu, 2.1020 CuSn6, 2.1096 G-CuSn5ZnPb	≤500		○
Laiton à copeaux courts, à copeaux longs	2.0380 CuZn39Pb2, 2.0401 CuZn39Pb3, 2.0410 CuZn43Pb2	≤600		○
	2.0250 CuZn20, 2.0280 CuZn33, 2.0332 CuZn37Pb0,5	≤600		○
Bronze, à copeaux courts	2.1090 CuSn7ZnPb, 2.1170 CuPb5Sn5, 2.1176 CuPb10Sn	≤600		○
	2.0790 CuNi18Zn19Pb	≤850		○
Bronze, à copeaux longs	2.0916 CuAl5, 2.0960 CuAl9Mn, 2.1050 CuSn10	≤850		○
	2.0980 CuAl11Ni, 2.1247 CuBe2	≤1000		○
Therm durcissables	Résine époxy, Resopal, Pertinax, Moltopren	≤150		○
Thermoplastiques	Plexiglas, Hostalen, Novodur, Makralon	≤100		○
renf. de fibres d'aramides	Kevlar	≤1000		○
renf. de fibres de verre ou carbone	GFK/CFK	≤1000		○



HARTNER

≤10xD

86722
WN
VHM
86686
10xD
F
Aciers
20

86725
WN
VHM
86686
10xD
a
Aciers inoxydables
24

86723
WN
VHM
86686
10xD
Y
Fonte
28

86724
WN
VHM
86686
10xD
○
Alliage Al/Al
32

86729
WN
VHM
86686
10xD
F
pour poutrelles en acier
40



v _c m/min	Gamme d'av. n°
100	5
95	4
100	6
95	5
100	5
95	5
90	4
90	5
85	4
100	6
90	5
70	4
70	4
70	3
55	4
50	3
55	2
50	2

v _c m/min	Gamme d'av. n°
25	1
55	2
40	2
35	2
70	6
25	1
40	2
35	1

v _c m/min	Gamme d'av. n°
80	6
70	6
100	7
80	6
60	5
60	5
60	5
60	5

v _c m/min	Gamme d'av. n°
150	6
150	6
130	6
105	6
150	6
70	5
150	6
110	5
70	5
50	5
45	5
35	4

v _c m/min	Gamme d'av. n°
85	4
70	4

LE PROGRAMME HARTNER



▼ FU 500 / FN 500



▼ FORETS DE PERÇAGE
POUR FORAGES PROFONDS



▼ FORETS INOX



▼ MICROFORETS



▼ OUTILS DE TARAUDAGE



▼ FORETS TS



▼ TF 100 MULTI-MILL



▼ FRAISES EN CW



▼ FRAISES À CHANFREINER



▼ MULTIPLEX



▼ MULTIPLEX HPC



▼ AUTOMATE DE GESTION
D'OUTILS TM

HARTNER GMBH

Boîte postale 10 04 27 | 72425 Albstadt | Allemagne
Tél. +49 74 31 125-0 | Fax +49 74 31 125-21 547

www.hartner.de

Les éventuelles modifications des textes ou fautes d'impressions ne justifient aucune revendication.
Nous livrons selon nos conditions générales de livraisons et de paiements. Sur demande, ces conditions seront mises à votre disposition.

184 223/20004-125 | Printed in Germany | 2019